

The
Crawfords
AUTO REPAIR

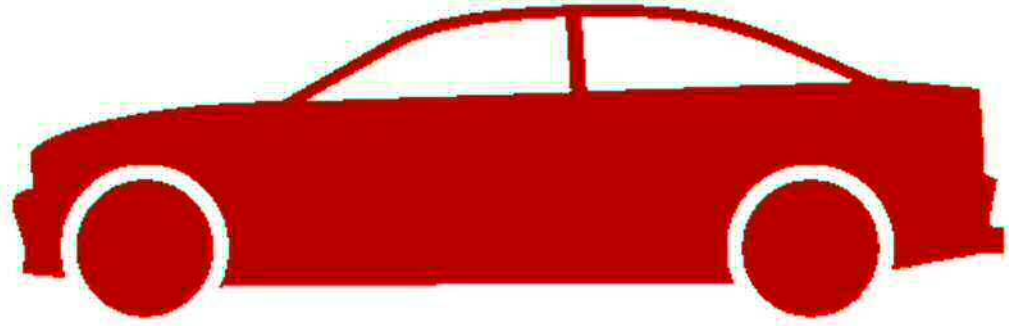

Guide to
Beginner's Auto
Maintenance & Repair

Jeff Crawford

Presented by:



About the Author: Jeff Crawford has over 20 years of experience as a mechanic and auto technician. He has seen all aspects of the auto repair industry from small shops to large dealerships. He is the co-owner of Crawford's Auto Repair in Mesa, Arizona 85210. www.CrawfordsAutoService.com.

The Crawford's Auto Repair Guide to Beginner's Auto Maintenance & Repair

By Jeff Crawford, Crawford's Auto Repair

Contributing Author: Rex Kimball, Mirex Marketing

Text copyright © Jeff Crawford, Rex Kimball

All rights reserved for printed and all digital formats. The following license is granted in PDF:

This book is available in PDF for free, and it can be reproduced, shared and sold for profit royalty-free in PDF, but it cannot be changed or adapted in content or format without the authors' consent. Go go <http://www.crawfordsautoservice.com/crawfords-auto-repair-guide-free-ebook/> to download for free.

Many of the images in this book are protected by copyright as cited. Some images are in the creative commons with "free use" licenses. Some are in the public domain or presumed to be in the public domain. Claims of any inaccuracies should be brought to the authors' attention to have the images in question removed from this book.

Crawford's Auto, Crawford's Automotive, Crawfords Auto Service, Crawford's Auto Repair, CrawfordsAutoService.com, and the Crawford's Auto Repair log are trademarks of Crawford's Auto Repair in Mesa, AZ 85210

Mirex Marketing and MirexMarketing.com are trademarks of Mirex, LLC in Arizona.

All other copyrights and trademarks are property of their respective owners.

This book is for informational purposes only. The authors are not liable for any accident or injury that may occur when working with motor vehicles. By proceeding to read this book, you agree to these terms.

This book is intended for a general audience. Also, Boy Scouts will find it useful for completing the Automotive Maintenance merit badge. Boy Scouts are welcome to come to the shop for assistance. This is not an official publication of the Boy Scouts of America.

The content in this book is also taught as live lessons to the local community in Mesa, AZ. Go to <http://crawfordsautoservice.com/free-automotive-classes/> for details.

Contents:

Chapter 1: Safety Rules & Introduction to Tools 2

Chapter 2: General Maintenance15

Chapter 3: Dashboard Indicator Lights 27

Chapter 4: Tires 32

Chapter 5: The Internal Combustion Engine & Engine Oil43

Chapter 6: Cooling System 46

Chapter 7: Fuel System49

Chapter 8: Electrical System52

Chapter 9: Drive Train 56

Chapter 10: Brakes64

Chapter 11: The Auto Repair Industry67

Chapter 12: How to Buy a Car71

Chapter 1: Safety Rules & Introduction to Tools

Automotive Maintenance Safety:

Automobiles are big and heavy with lots of mechanical moving parts. In the right environment a vehicle can be maintained and repaired safely and effectively. However, in the wrong environment repairing a vehicle can be dangerous. Follow the tips in this chapter to stay safe.

Basic Shop Rules:

- Never work alone
- Wear eye protection
- Avoid loose clothing or hair
- Stay clear of moving parts of a running vehicle
- Be aware of hazardous chemicals and keep a flushing station nearby for eyes and skin (at home this could be a bathroom sink or shower).
- Keep proper clean up materials in case of an accidental spill (see below)
- Don't mix your work space with other cluttering materials such as home storage, garden tools and other items.
- Never go under a vehicle that is elevated improperly (the jack to change the tire is NOT sufficient, see more details below)
- Know where the fire extinguisher is and have a planned exit route. The fire extinguisher should be kept in working order and in a place with easy access.
- Keep an emergency response number handy and posted clearly where others can see it.
- Keep an emergency kit in your vehicle for roadside emergencies or repairs.
- Consult your vehicle owner's manual for specific safety rules regarding your vehicle

Proper Clothing and Hair:

Always wear safety goggles for eye protection. Vehicle repair involves the use of many types of fluids which can splatter and eye contact should be avoided.



Eye protection

Image credit: CC-BY-Glenn McKechnie

One of my first bosses didn't have any feeling sensation in his right hand. He couldn't feel touch or pain in that hand. He was working alone one night and his hand got caught in the fan belt while the engine was running. He was conscious long enough to get the engine to stop running with his other hand, but his right was stuck and he couldn't get out on his own. He eventually lost consciousness and lay there bleeding for three hours by himself. Bleeding this long could easily have resulted in death. Luckily he only lost his fingers. While it was his hand and not a piece of clothing that got caught, the same principle applies. If a piece of clothing or hair gets caught it won't be long before a hand or face gets dragged in with it.

Do not wear ties or any loose, hanging clothing. Do not let pony tails down or leave any loose strands of hair. Bundle your hair up if it's long. Do not wear necklaces, rings or other jewelry. Some may remember Mr. T, the Mohawk-bearing muscle man from the 1980s sitcom *The A-Team*. He often wore about 50 lbs. of jewelry and frequently worked on motor vehicles. This was a blatant violation of mechanic safety rules. Only a person who can get thrown out of an airplane, flip a jeep, and come out of machine gun fire without a scratch can work on engines that way.

Ideally the best clothing for performing automotive maintenance and repairs is a mechanic's jumpsuit. It's durable, comfortable, there are pockets for tools, and there is nothing loose that can get caught and pulled into moving parts.

Avoid slips, falls and hazardous chemicals:

Hazardous chemicals can include gasoline, oil, coolant, and other vehicle fluids. Avoid contact with eyes and mouth. If you ever have contact with eyes then flush with cool water for several minutes. Some car fluids can be acidic, such as battery fluid. If you ever start to feel burning, then flush with cool water for several minutes. If burning continues then seek medical attention.

Proper clean up materials include shop rags and "oil dri", which is simply kitty litter without the fragrance. When a spill occurs you should spread enough "oil dri" over the spill to absorb the entire spill. Then sweep it up with a broom and dustpan and throw it away.



Oil Dri

Avoid clutter in your workspace that can act as fall hazards. Keep storage and non-automotive tools in other areas. Also, clean up tools after you're finished.

Proper Lifting Points:

A motor vehicle is a 4,000+ pound piece of machinery that could fall on top of you. Never go under a vehicle that is not elevated properly. If the vehicle *is* elevated properly then there should not be any problem.

Vehicles should only be lifted at their proper lifting points. The proper lifting points on a vehicle are the locations on the vehicle where you place the jack to lift the vehicle and where the jack stands are placed to keep the vehicle elevated. Lifting points are different on every vehicle. The owner's manual will specify where the lifting points are for your specific vehicle. Often vehicles have lift points marked on the running board or rocker panel. There are a couple of disastrous events that can happen during an attempt to raise a vehicle without using the proper lifting points. The weight of the car pressing down and the jack pressing up can damage the body of the vehicle. Or worse, the jack could tip or slide while a person is underneath the vehicle.

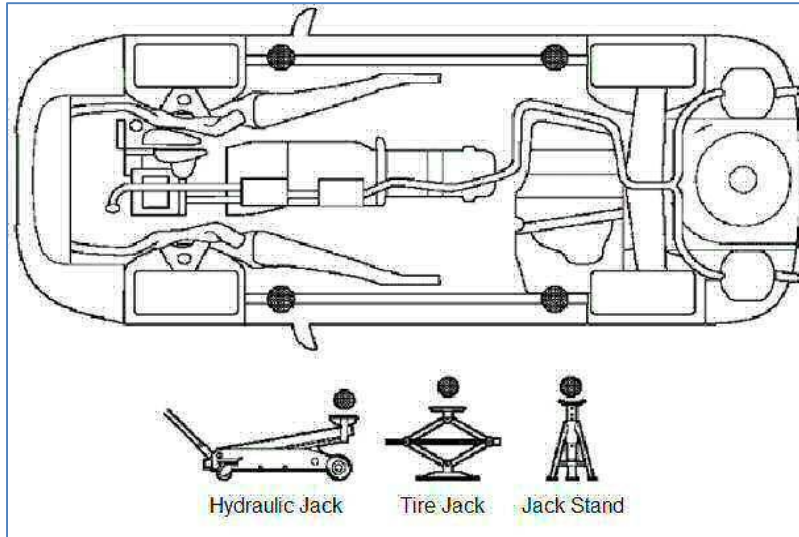

An illustration which demonstrates vehicle lift points for a sample vehicle; consult the owner's manual for the lift points of a specific vehicle.

Any vehicle that has a frame can be lifted by the frame. When the front is lifted the jack is usually placed under the suspension cross member. When lifting the rear the jack is placed under the axle if it has a solid axle. If it doesn't have a solid axle then it should be lifted by the factory recommended lift points.

Vehicles should always be on firm, level ground. If the ground is not level then the car may roll and tip the jack. A jack or a jack stand can also slip out or fail to hold the vehicle in an elevated position when the ground is not firm, such as on a dirt road or when there is ice or snow.

There are different types of jacks and jack stands. A jack is used to raise the vehicle either by hydraulic pumping or hand cranking. A jack stand is used to keep the vehicle elevated and has a firm square base. One type of jack that people are most familiar with is the one that is included with the spare tire kit. This is to be used only for changing the tire and it is not sufficient for keeping a vehicle elevated when working under the vehicle. The jack used for changing tires often has a four point rectangular base. This is not as stable as a square base.



Hydraulic jack with hand-pump mechanism

When minor repairs are being performed, such as changing a tire, it is permissible to raise just one corner of the vehicle, or the front or the rear. The vehicle is first raised with a jack and then placed on jack stands. (Do not go under the vehicle while it is elevated by a jack). The vehicle should be equally balanced on the jack stands.

A mechanic's shop may have industry jacks or hydraulic lifts. These can be used to raise the vehicle and keep it elevated. These lifts can raise the entire vehicle at the same time. When lifting the entire vehicle the center of gravity should be positioned evenly with the lifting hoist arms. This is evident when the vehicle is raised and all tires lift off the ground at the same time. Most vehicles are front-heavy due to the engine block. However, many work trucks are balanced to have the center of gravity in the middle.

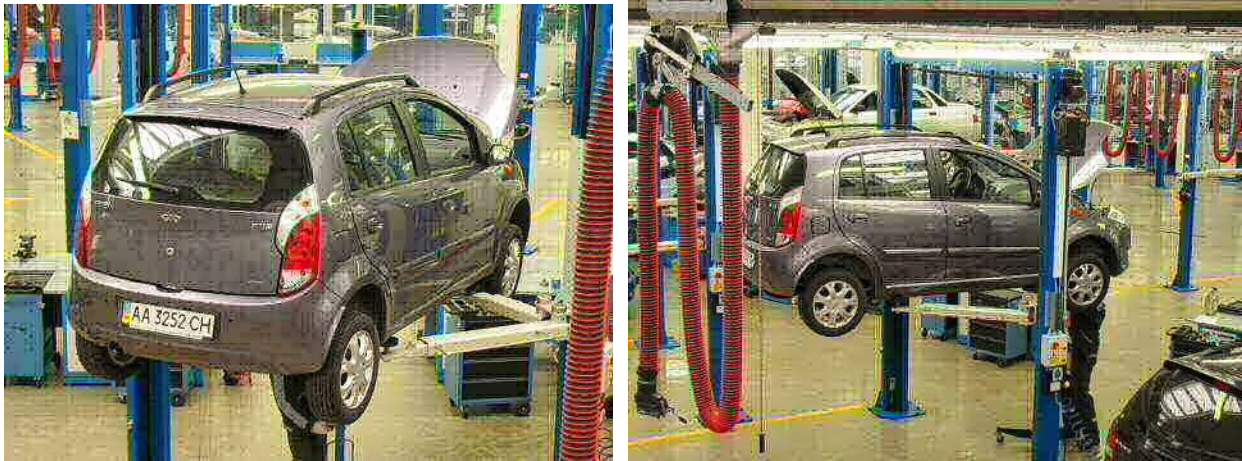

Hydraulic lift with hoist arms that raise the vehicle on its lifting points. The lift consists of two vertical blue beams and four white hoist arms. Two white hoist arms on the other side of the vehicle are not seen in the pictures.

Image credit: CC-BY-ANT Berezhnyi on Wikipedia



Another hydraulic lift that raises the car on its tires

More instructions will be given for lifting a corner of the vehicle to replace a spare tire in Chapter 4. The owner's manual should be consulted any time when lifting the vehicle.

Emergency Preparedness and Response:

In an emergency, preparedness and a quick response can save a life. Although it is relatively rare, a fire can occur when working on motor vehicles. Some vehicle fluids are flammable. They can combust with excess heat or when a faulty electrical wire creates a spark. Keep a working fire extinguisher in an accessible place. All shop workers should know where the fire extinguisher is. An ABC or "tri-class" fire extinguisher is appropriate for auto repair shops. Also, have a plan for an emergency escape if a fire becomes uncontrollable.

Keep an emergency response number posted clearly where everyone can see it.

Keep a first aid kit handy for minor injuries, like superficial cuts and scratches.

Have a flushing station nearby for any vehicle fluid contact with eyes and mouth, or with skin if the fluid is acidic.

Introduction to Tools Used by Mechanics:

A commercial mechanic's shop will usually have industry-standard tools, such as a torque wrench, hydraulic lifts, pneumatic (air-operated) tools, and electronic devices that connect with the vehicle's computer to receive diagnostics. However, a startup repair shop or a highly proficient mechanic at home could get most jobs done with a \$200 set of tools if needed.

The most common tools in a mechanic's set include the following:

Flashlight. A flashlight is one of the most-used tools in an auto repair shop. It helps the mechanic see anywhere for visual inspections, maintenance and repairs.



Flashlight

Socket sets and wrenches. These have two different measurement systems. One is metric and one SAE (or standard). The metric system has measurements in millimeters (mm). SAE has measurements in inches or fractions of inches (1/4, 5/16, etc.). Wrenches often have an open end and an opposite box end.



Socket Ratchet Wrench

Image credit: CC-BY-SA-Heron2 on Wikipedia



Wrench set

These wrenches have an open end and a box end
Image credit: CC-BY-SA-Ildar Sagdejev on Wikipedia



Pneumatic (air-powered) wrench

Image credit: CC-BY-SA-Bushytails on Wikipedia



Oil Filter Wrench

Has a prying mechanism like other wrenches but one end has a belt that wraps around the object being unscrewed, which is much bigger in diameter than the regular bolts and hex-head screws that other wrenches are used for.

Image credit: CC-BY-SA-Three-quarter-ten on Wikipedia



4-way lug wrench

Image credit: CC-BY-SA-Steffen Heinz Caronna

Screwdrivers, both Philips head (the cross-section looks like a cross or plus sign) and flat tipped (or slotted). When using screwdrivers, try to match the size of the screwdriver head with the screw. Also try to avoid stripping the head of the screw (this has occurred when you can firmly turn the screwdriver against the head of the screw continually and the screw never rotates).



Screwdriver set



Screwdriver tips showing Philips (left) and flat or slotted (right)

Jacks. These are used to lift the vehicle. Some are rotated by hand. Other higher-end jacks are pumped. Some are hydraulic.



Hydraulic jack

Image credit: CC-BY-SA-Nerijp on Wikipedia



Spare tire kit with a spare tire, lug wrench and tire jack. The tire jack is already placed under the lifting point and partially cranked.

Image credit: CC-BY-Kurt Nordstrom

Jack Stands. These are used to keep the vehicle elevated after it has been raised with the jack. They have a wide square base and come to an apex where the car rests on them.



Two jack stands, the lever shown on these stands is not used to raise the vehicle but to adjust the height of the stands to keep the vehicle raised.

Pry bar. This can occasionally be used to tension a belt.

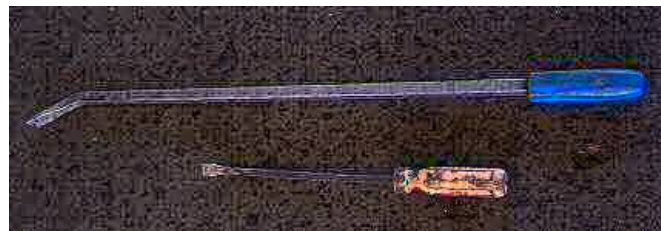

Two pry bars, different sizes

Hammer. This can be any type of hammer and it is used on occasion, such as when freeing a stuck drum or rotor from its hub.

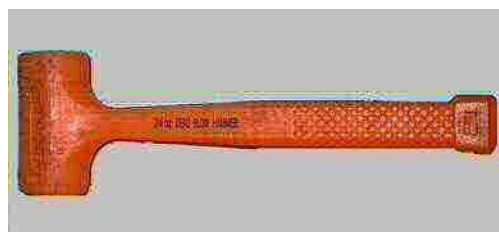

Hammer

Test Light. This used to test fuses (see Chapter 2).



Test light

Funnel. Used to fill vehicle fluids.



Funnel (yellow) for car fluids
Image credit: CC-BY-SA-Dvortygirl on Wikipedia

Drain Pan. Used to collect vehicle fluids when changing fluids and filters or flushing systems.



Draining oil

Tire Pressure Gauge. Used to measure tire pressure.

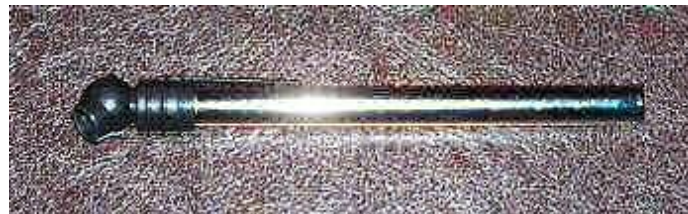

Tire pressure gauge.

Battery Tester. Used to check the battery to see if it is charged.



Battery tester

Computer Scanner. Connects to the vehicle computer to receive diagnostic trouble codes (DTCs)



Auto scanner which receives DTCs from the vehicle's computer
Image credit: CC-BY-SA-Florian Schaffer

There are many other tools that can be used. But these are the most basic.

Now that we've reviewed safety rules and gone over the tools used in a mechanic's shop, you're ready to continue to the next chapter -- General Maintenance.

Chapter 2: General Maintenance

This chapter on general maintenance may be one of the most applicable for the average person to care for his or her own vehicle. We'll discuss the vehicle owner's manual, vehicle fluids, fuses, belts and hoses, vehicle lighting, and the air filter.

Vehicle Owner's Manual

All vehicles are different and the owner's manual for each make and model is the most useful reference for maintenance and repair of that specific vehicle. Despite the fact that it can often look thick, complicated, and boring on the surface, vehicle owners should become familiar and comfortable with the owner's manual. They're not so bad once they're finally opened. Almost any topic regarding your vehicle's maintenance can be found in the index.

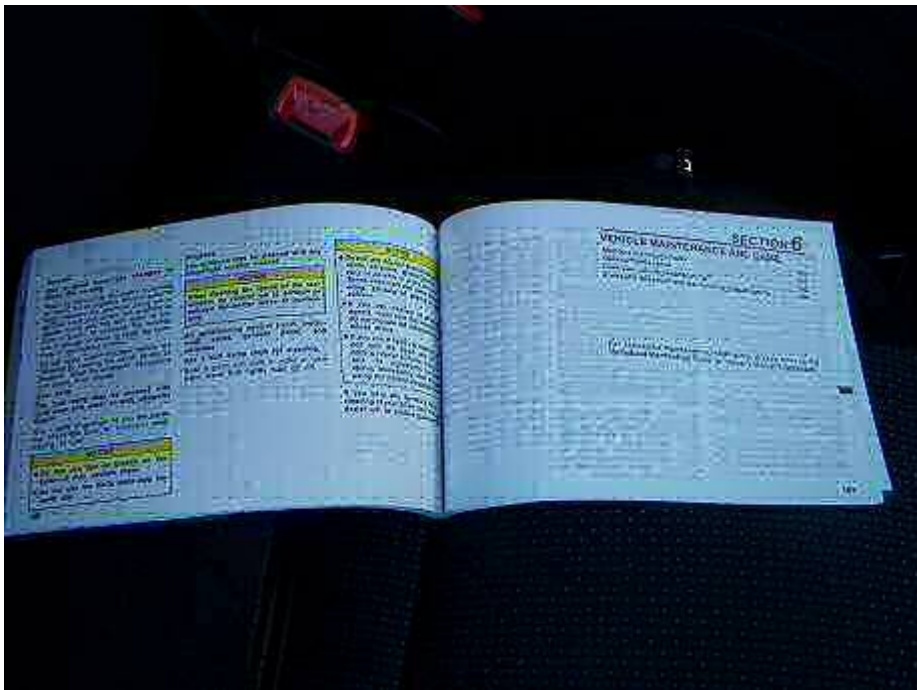

Owner's Manual

The owner's manual will have a maintenance chart. The chart will include such information as when to change the oil, rotate tires, replace the air filter, inspect fuel cap and lines, change other fluids (transmission fluid, etc.) and other maintenance issues. Your vehicle may have different maintenance requirements at 30,000 miles, 90,000 miles, 150,000 miles and at other intervals as indicated specifically in your owner's manual.

Being familiar with the maintenance chart in your owner's manual can help you save money when taking your car to the mechanic for maintenance checks. Sometimes the repair shop will suggest additional services that aren't necessary.

If you don't have the owner's manual for your car then you may be able to find one online by using Google or another search engine. Search the website for the make of the vehicle. You could also try your local library.

Vehicle Fluids:

Vehicle fluids include brake fluid, engine oil, coolant, power steering fluid, windshield washer fluid, transmission fluid and battery fluid. Fluid level information and the location of each fluid reservoir can be found in the owner's manual for your particular vehicle. (Any images in this chapter are illustrative of one example and your vehicle may look different).

Brake Fluid: On most vehicles the reservoir for brake fluid is clear. You can check the fluid without removing the cap. There will be a marking on the reservoir that indicates minimum and maximum level. You'll want to make sure that the level is between those two marks. This fluid should never need to be topped off during maintenance. Low fluid is an indication of a problem. If the fluid is low then you may want to bring it to a mechanic, depending on your own skill level. Most vehicles have a dashboard light that illuminates when the brake fluid is low. (In Chapter 3 we'll go over all the dashboard lights, and in Chapter 10 we'll go over brakes).



A brake fluid reservoir. Notice the MAX and MIN markings.
Image credit: CC-BY-Frettie on Wikipedia

Engine Oil. Engine oil should be checked each time the vehicle is refueled (i.e. each time you go to the gas station). Most engines, but not all, have a dipstick to indicate the oil level. Typically the handle is yellow. Follow these steps to check the oil:

- Turn the engine off.
- Remove the dipstick.
- Wipe off the end of the dipstick with a rag or paper towel.
- Put the dipstick back in.
- Take it out to look at the level at the tip

The stick will have marks on it. The “add” mark typically indicates one quart low. If an engine is leaking oil then the price of repairs can vary depending on which repair is needed and the make and model of the vehicle.

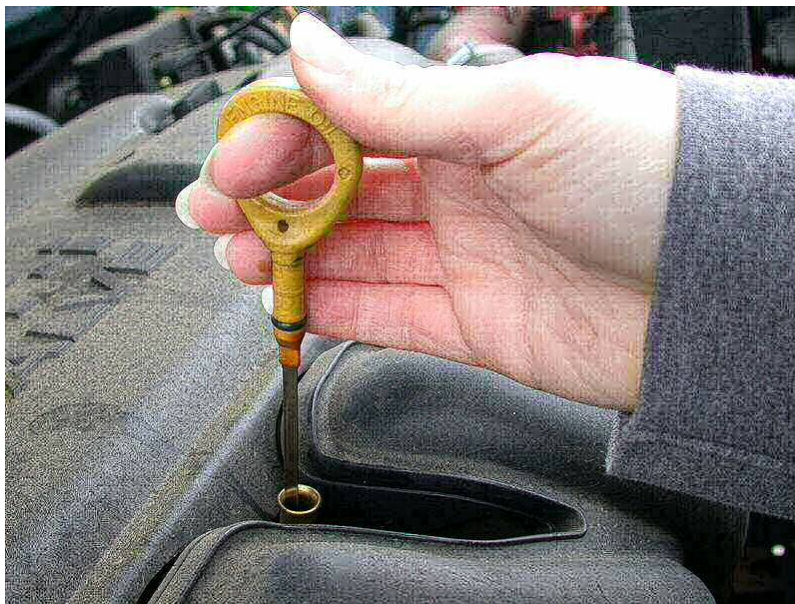

Oil dipstick (above) and oil level on a dipstick (below)
Image credits: both CC-BY-SA-Dvortygirl on Wikipedia



Coolant: Never open the cooling system if the engine is hot. If you've just been driving then don't open it. After you think the engine has cooled then you can lightly touch the radiator cap to test it. If it's still hot, then don't open it. Opening the radiator cap while the engine is still hot can shoot a six-foot geyser into the air and burn any skin it contacts. The best time to check the coolant is in the morning before the car is driven.



Coolant. Notice the green color; coolant can actually be any color (pink, orange, transparent, red, etc.)
Image credit: CC-BY-EvelynGiggles on Wikipedia

A low coolant level indicates a possible leak which should be investigated. A very small amount of evaporation of coolant can occur over time. As a rule, if you need more than one quart of coolant, that indicates a problem.

If the coolant is low then it needs to be replenished with the proper type of coolant and mixture. Consult the owner's manual for the proper type of coolant. The proper mixture is a 50/50 ratio of coolant and distilled water. It is important to use distilled water because the impurities in other water would circulate through the system and ruin the system over time. Coolant can be purchased pre-mixed in a 50/50 solution if desired.



50/50 pre-diluted coolant. Image credit: CC-BY-dno1967 on Wikipedia

Power Steering Fluid: There may be a clear reservoir for power steering fluid. If there is, then it can be checked the same way as the brake fluid described above. If the power steering fluid is not in a clear reservoir then it will have a dipstick. Refer to the owner's manual for the location of the reservoir and the type of fluid that should be used. Low power steering fluid is an indication of a leak and it should be investigated. At that point the driver may also notice changes in steering performance.



Power steering reservoir (black tank). Notice how the cap is labeled.

Windshield Washer Fluid. There may be a clear reservoir or a dipstick for windshield washer fluid. Refer to the owner's manual for the location. If you live or travel in cold climates, below 32 degrees, you need to make sure that you use washer fluid with antifreeze.



Windshield washer fluid

Image credit: CC-BY-SA-Hamedog on Wikipedia

Transmission Fluid. Refer to the owner's manual for the location of the transmission fluid. Some vehicles have a dipstick but many new vehicles do not have one. In some vehicles you have to go underneath the vehicle to check this fluid. If the fluid is low, then there is a leak and it should be investigated. The fluid should also be red. If it is black and/or has a burnt smell then there is a problem with the transmission.



New transmission fluid, red in color

Battery Fluid and Terminals: If the battery is clear then you can look at the level of the fluid. Most modern vehicles do not have clear batteries. Any corrosion or signs of leaks around the battery are indications of a problem. Corrosion can be a green or white powdery substance. Don't ever allow corrosion to come in contact with the skin or eyes because this is an acid and it will burn. If corrosion is present at all, the battery may need to be replaced or there could be a problem with the charging system. Excessive discharging of the battery without the engine running (i.e. listening to the radio, keeping the cab lights on or using any accessory with the engine off) can cause the battery to overheat, which leads to early battery failure and leakage of battery acid. If the battery fluid is low, only use distilled water to refill it. Never add acid to a battery.

The presence of corrosion indicates a problem that should be addressed. However, as a temporary fix, you can clean off the corrosion to get the car started. Start by rinsing off the corrosion with the garden hose. Then disconnect the terminals starting with the negative terminal first, then the positive terminal. Use a mixture of baking soda and water or battery terminal cleaner to rinse off the terminals and battery posts. You'll see the baking soda reacting with the corrosion to form fizz and bubbles. Use a wire brush or scraper (depending on the type of terminal) to clean the inside of the terminal and battery posts. Then rinse again with more water. Once the terminals and battery posts are clean, reattach the terminals starting with the positive terminal first, then the negative terminal. It is not sufficient just to clean off the corrosion. Again, the presence of corrosion indicates a problem that should be addressed.



Car battery

Fuses

Consult the owner's manual to locate the fuse boxes in your vehicle. They can be anywhere in the vehicle. Modern vehicles use blade type fuses. The part of the fuse that you'll see initially is plastic and color-coded. When the fuse is removed it can have a similar shape to a square letter "C" with the arms of the "C" being metal and the back of the "C" being the color-coded plastic. The color coding system for fuses has been used since the early 1980s. Older fuses are made of glass tubes. The color coding for modern fuses is universal and indicates the amperage of the fuse.

Violet – 3 Amp
 Pink – 4 Amp
 Orange - 5 Amp
 Red - 10 Amp
 Blue - 15 Amp
 Yellow - 20 Amp
 Clear - 25 Amp
 Green - 30 Amp
 Orange – 40 Amp
 (and many others)

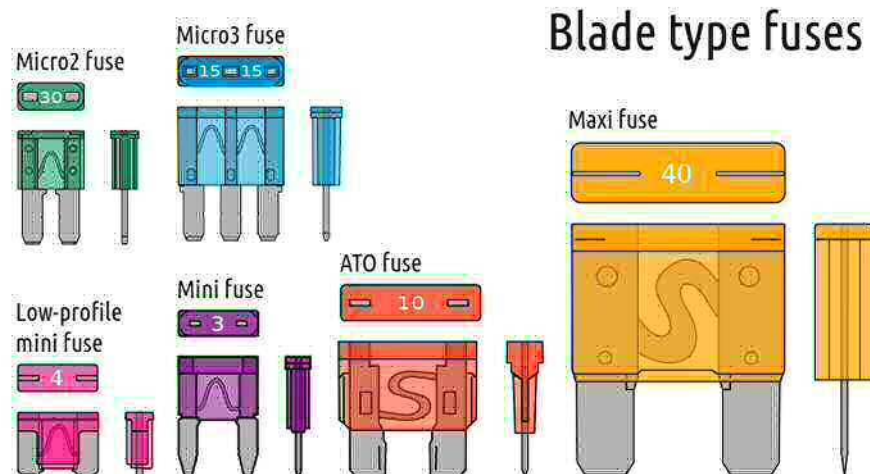

Blade type fuses used in modern vehicles. Most of them have a "C" shape (or "E" shape, facing down in the image). In a blown fuse, the "S" or upside down "V"s in the middle will be broken (called the element).

The image shows the top view of each fuse just above each side view; notice that each top has metal contacts that are not covered by colored plastic.

Image credit: CC-BY-SA-Havarhen on Wikipedia.



Glass tube fuse used in older vehicles
 Image credit: CC-BY-SA-Aka on Wikipedia

There are two ways to test the fuse: one is by removing the fuse to look at it and the other is to use a test light.

When testing it by removing it, simply pull it directly out and look through the color-coded plastic to see if the element (connection in the center) is intact. If it's open, then the fuse is burnt out. Sometimes you'll also see a black singe that makes the transparent plastic more opaque. Never remove more than one fuse at a time. This helps to keep track of where the fuse was pulled from and permits easy replacement of the fuse in the correct place. If multiple fuses happen to get pulled at the same time then the size and placement of each fuse can be found in the owner's manual.

An easier and faster way to test the fuses is with a testing light since the fuses don't have to be removed. The testing light looks like an electric screwdriver with a pointed tip. The wire end, or black end of the testing light must be grounded to a clean, unpainted metal surface of the vehicle. If you can't find a place on the body of the vehicle, then you can always ground it to the negative terminal of the battery. The point of the testing light is placed on the metal contacts of the fuse. There is a metal contact on each side of the fuse's color-coded plastic (on the back of the "C"). Upon contact the display will indicate if the fuse is still good.



Test light

Not all fuses have power all the time. So the test should be performed with the key turned to the "on" position in the ignition and the headlights turned on (the engine does not need to be running). Even with the key and headlights turned on, there is one other fuse that will not have power, which is the crank fuse. The crank fuse only has power when the key is turned to the crank position while starting the engine. This particular fuse does not need to be tested unless the vehicle won't crank.

Belts & Hoses



Two hoses and a belt are seen in this image
Image credit: CC-BY-SA-Kolossos on Wikipedia

If a belt squeals after starting the engine or while driving then this indicates a problem with belt tension. Most modern vehicles have automatic belt tensioners which keep the belt at the appropriate tension. Checking the belt tension varies by make and model. Modern vehicles only have one belt, but older vehicles have an individual belt for each accessory of the engine (i.e. power steering, air conditioning, and alternator). Consult a workshop manual for the proper methods for checking belt tension. (The workshop manual or service manual is different from the owner's manual and may be found at the local public library or ordered online). Belts can also be checked by visual inspection and touch for signs of cracking, fraying, or glazing. Glazing means the drive surface of the belt will be shiny.

Hoses can be checked visually and by touch for signs of cracking, swelling, or leaks. If the engine is cool, then squeeze the hose to check for softness. If there is any variation from hose to hose within the same vehicle then that could indicate a problem.

A cooling system pressure tester can be a useful tool to pressurize the cooling system and check for leaks or swollen hoses. This tool be rented from an auto parts store and should come with instructions for use. You'll attach it in place of the radiator cap and hand-pump it as you watch the gauge. Never exceed the indicated pressure that is written on the top of the radiator cap. Most modern cars have a limit of 16 psi. Again, do not open the radiator cap if the engine is still hot. (See also Chapter 6 for more information on the cooling system).

Vehicle Lighting

Vehicle lighting includes instrument panel lighting, warning indicator lights, left and right turn signals, brake lights, hazard lights (which have a distinct circuit from the turn signals even though the display is in the same place), headlights and tail lights, front marker lights, the license plate light, and lights for the cab and trunk. Checking vehicle lighting goes quicker and smoother with two people, and in the case of the brake lights two people are required.

The instrument lighting is all of the backlighting for the instrument cluster (all the gauges, speedometer, fuel gauge and others). The instrument lighting can be checked by turning on the headlights at night or in a dim garage. Check to see that all the gauges are clearly visible. There should not be any dark spots on the cluster.



Dashboard showing gauges and warning indicator lights
Image credit: CC-BY-SA-Tagaz Vega

The warning indicator lights on the dashboard include the brake light, oil light, check engine light, anti-lock brake (ABS) light, airbag light, tire pressure monitor, engine temperature light, and others -- all of which can be found in the owner's manual. All of the warning indicator lights will turn on for a set amount of time (about a minute, but varies per vehicle) when you turn the key to the "on" position without cranking the engine. Once the engine is running, none of these lights should be on (even the seat belt light should be off, indicating that you're wearing your seat belt). If one is on, then it indicates a problem with its correlating system. The number of lights and types of lights will vary by make and model. Some vehicles have features that others don't, such as traction control. (We'll discuss indicator lights in detail in Chapter 3).

Exterior lighting is checked with the key turned to the "on" position in the ignition (or with the engine running, but it's not necessary to have the engine running just to check the lights). Turn on the headlights. Check all four corners of the vehicle. On both sides (right and left, or driver side and passenger side) the same number of bulbs should be illuminated. There should be two front marker lights that are orange, two tail lights, and a license plate light.



Rear lights of a vehicle with the brake lights illuminated.
Image credit: CC-BY-SA-Paultantk on Wikipedia

Turn the left turn signal on. Check the left front and left rear of the vehicle for blinking lights. Some vehicles have more than one bulb for the turn signal and some even include a signal in the side rearview mirrors. Be sure every applicable bulb is illuminating. Some vehicles have a cornering lamp, which is a clear lamp on the front of the vehicle which illuminates corners while turning. This should be illuminated but it will not blink.

Turn the right turn signal on. Check the right front and right rear of the vehicle for blinking lights. Be sure all applicable bulbs are illuminating. Check the cornering lamp if applicable.

When the turn signal is on and the indicator is blinking fast or not blinking at all, these are indicators of a failed bulb.

Brake lights require two people for inspection. One person presses the brake pedal while the other person checks the rear of the vehicle to make sure all the brake lights are illuminating, including the high mount brake light in the rear window if the vehicle is equipped with one.

Activate the hazard switch. Check to make sure that there are flashing lights with an equal number of bulbs on all four corners. The hazard lights are wired separately from the turn signals, so it is important to check the hazard lights even if the turn signals have been checked.

Air Filter

Consult the owner's manual for the location of the air filter. Remove the air filter. Inspect for visual signs of dirt and debris. Hold the filter up to a fluorescent light; you should be able to see light coming through the filter. If there is any doubt then change it. It's cheap preventative maintenance and it helps preserve fuel economy. (The air filter is discussed more in Chapter 7).



Various air filters.

Image credit: CC-BY-SA- Maly LOlek on Wikipedia

Chapter 3: Dashboard Indicator Lights

The instrument panel on your dashboard has multiple gauges and indicators. These may include the fuel gauge, speedometer, tachometer, oil pressure, and engine temperature. Most are self-explanatory-- the speedometer measures your speed, etc. The one that may not be self-explanatory is the tachometer, which indicates engine speed in revolutions per minute (RPM). It often has a red zone which you should never exceed.

In the previous chapter we checked all the vehicle lighting which included the dashboard symbols. Now we'll discuss what these symbols mean. As always, a better resource to learn the meaning of each dashboard symbol for a specific vehicle is the owner's manual for that vehicle. The ones that are included in each vehicle will vary by make and model.

Dashboard lights can be red, orange (or yellow) and blue. Generally when a red light comes on while driving, it means you should immediately pull over safely and call a tow truck. However there are some exceptions – some lights which are generally red can be yellow or orange, and some red lights can be fixed immediately (seat belt light – put your seat belt on, door ajar light – close all the doors). Orange or yellow lights generally indicate that there is a problem with your vehicle, but it is safe to drive to a repair facility or your home residence to investigate further. This also has some exceptions. It is always best to consult the owner's manual for a particular vehicle.

The following are the general symbols:



Airbag Light or Supplemental Restraint Warning Light: Red, Orange or Yellow. Whenever this light illuminates the air bag system senses a problem, which could be a safety issue. It doesn't necessarily mean that the airbags will not work. The airbags might or might not still deploy during an accident. The light means that there is a *part* of the airbag system that may not work.



Anti-Lock Brakes Light: Orange or yellow light. This indicates a failure in the anti-lock brake (ABS) system and anti-lock brakes are disabled. The purpose of the ABS is to allow steering control of a vehicle while braking and to avoid skidding during a panic stop. If this light is on, then normal conventional brake function will continue. If it's on in the event of a panic stop then the vehicle will skid. Have the vehicle serviced.



Brake Light: Red light, immediately pull over safely and have the vehicle towed (or disengage the parking brake if applicable). This light indicates that there is something wrong with the brakes. There could be a low brake fluid level, there could be a hydraulic brake failure, or the parking brake is engaged.



Change Oil Soon. Orange or yellow light. This light indicates that routine oil change and maintenance is due. It's based on revolutions of the crankshaft, which is even more accurate than basing routine oil changes on mileage.



Check Engine Light: Red or yellow light. There is a problem with the vehicle emissions and the vehicle's computer will have diagnostic trouble codes (DTCs) which will be retrieved when the vehicle is inspected. The light may come on and then off. If there are any performance issues with the way the vehicle is driving, then pull over and have it towed. If the light comes on and stays on, or comes on and then flashes during acceleration, then immediately pull over safely and have it towed to a shop. Don't confuse the check engine light with the "service *vehicle* soon" light below.



Door Ajar Indicator Light: Red light. One of the vehicle doors is open. Close the open door before proceeding to drive. There may also be a separate light for the trunk.



Glowplug Indicator Light: This light is only seen in vehicles with diesel engines. The glow plug is a device that is used to help get the diesel engine started.



High Beam Indicator or Brights. Usually blue, but can be red on older vehicles. This indicates that your brights are on.



Low Coolant Level Light: Red, Orange or yellow light. This light indicates that the engine coolant level is low, which could be due to a leak. It is still safe to drive as long as the engine temperature light is not on. In some vehicles the first symbol above, the thermometer symbol, can also be a temperature light. (Remember from Chapter 2 that the coolant level should not be checked while the engine is hot). Some vehicles can have a blue thermometer symbol. Consult the owner's manual for its description.



Low Fuel Light: Yellow or Orange. This light indicates that fuel is low. It could also be a simple round light that illuminates when the fuel gauge is nearing empty.



Low Oil Level Light: Yellow or Orange. The oil level is low. Refill the oil as soon as possible and bring the vehicle to a shop to see why it was low.



Low Oil Pressure or Engine Oil Pressure Light: Red light (immediately pull over safely). Once you pull over you could check your oil level and add oil if it's low. If the light continues illuminated then you should have your vehicle towed to a facility. Catastrophic engine failure will occur if the oil pressure is low. Repairs for these damages can be very expensive.



Parking Brake Light: Red light. The parking brake is engaged or not fully released. Release it completely before driving.

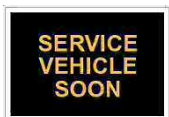

Service Vehicle Soon: Yellow light. This light may be used in conjunction with other lights. Depending on which other lights are illuminated, there may be a problem with the anti-lock brakes (ABS), brake hydraulic system, traction control system (TCS), or the

electronic suspension system. Don't confuse with the "Service *Engine* Soon" light, which is one of the possible check engine lights shown above.



Temperature Light (or Hot Light). Red light (immediately pull over safely, turn off the engine, and have it towed). This light means engine temperature has exceeded maximum parameters. Severe engine failure will result if you continue to drive. For a few extra moments while you're finding a safe place to pull over, you can turn on the heater to high, which dissipates heat from the engine. If the heater does not work, it is an indication that the coolant level is low, and that the vehicle should not be driven. The dashboard may also have a temperature gauge which has a thermometer symbol.



Throttle Control Warning Light: Yellow or orange. In some vehicles the throttle has an electronic control system. These lights indicate that there is a problem with the system. Have the vehicle serviced as soon as possible. In some makes and models the wrench light can be for other purposes. Be sure to consult the owner's manual.



Tire Pressure Warning Light: Yellow or orange. This light indicates that one or more of the tires has fallen below 25% of the recommended pressure. Have the tires checked soon.



Turn Signals and Hazard Light Display: These will only illuminate when a turn signal (left or right) or the hazard lights (both simultaneously) are turned on. If one stays on instead of blinking in rhythm or blinks slower or quicker than usual then there is a problem. One of the bulbs may need to be replaced or there is something wrong with the circuit.



Voltage Light. Red Light (pull over safely and get it towed). If this particular light illuminates while you're on the freeway then you may be able to proceed to the next

exit. This light indicates that voltage is below the minimum specification and your vehicle will stop running once the battery dies. Safely pulling over and having the vehicle towed is even more important at night since you'll lose the use of your headlights, which tend to drain the battery even quicker. Some of the samples are yellow; in this case you should still treat it as a red light.



Security Light. Red, Orange or Yellow. This indicates that there is a problem in the theft deterrent system. Sometimes the vehicle will not run if this light illuminates or blinks.

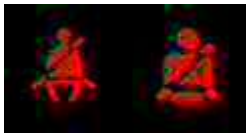

Seat Belt Light. Red light. This means that the driver and/or passenger do not have their seat belts fastened. Put on your seatbelts before continuing to drive. There is a reason why they show videos of people in car accidents to Driver's Ed students. They want you to understand that when you get behind the wheel you're potentially putting people in danger. Ideally, seat belts would be more like the harnesses used in roller coasters, which include two shoulder straps and a middle fastening device at the chest. The cross-over shoulder strap isn't very effective in comparison. It is designed that way for commercial purposes and to account for common human behavior. It's easier and quicker to have one buckle where the belt can be pulled over and fastened in one quick motion while the person is just getting into the car. While the conventional seat belt isn't 100% efficient, it is potentially the most important safety feature of the vehicle because it keeps the body harnessed and kept in the seat. Wear your seat belt!



Traction Control Light or Low Track Light: Yellow, orange or blue light. This indicates drive wheel speed is higher than the coasting wheel speed. For example, if you have front wheel drive, then the front wheel speed is higher than the rear wheel speed. This can be useful on ice, dirt or any low-traction condition. Be careful while driving in these conditions, especially when turning.

Once again, this is just a sample list. Your particular make and model could have other lights and/or it won't include all the lights listed above. Consult the owner's manual.

More detailed information on warning indicator lights can be found at <http://repairpal.com/warning-lights-chart>. Most of the images/symbols in this chapter were taken from this web page and are believed to be in the public domain due to the universality of these symbols. Some were taken from http://commons.wikimedia.org/wiki/Category:Dashboard_icons and other pages of Wikipedia.

Chapter 4: Tires

This chapter is all about tires. There may be more to these rubber doughnuts than many people realize. In this chapter we'll discuss tire specifications, how to check tire pressure, wheel alignment, the wear bar, how to change a tire, and old tire disposal.

Tire Specifications

There are two specification sets for tires including the tire manufacturer specifications and the vehicle manufacturer specifications. Whenever you take your car to a tire shop to get the tires changed, they have to meet these specifications by law. You can get a tire that goes above these specifications, but never below.

The vehicle manufacturer's specifications include speed rating, load and size. It is located on a sticker in the driver's door jamb of the vehicle and in the vehicle owner's manual. When buying a new tire you'll want to stick with a tire that meets the manufacturer's specifications because that's the kind of tire that the vehicle was built to use.



Vehicle Manufacturer specifications in the driver's door jamb of a vehicle. This indicates that the tires for this vehicle should be inflated to 30 PSI, except the spare which is 60 PSI.

The tire manufacturer specifications include the tire size, load, pressure, temperature, speed rating and tread wear. The tire manufacturer specifications indicate what the tire is made to withstand. These specifications can be found on the wall of the tire itself.

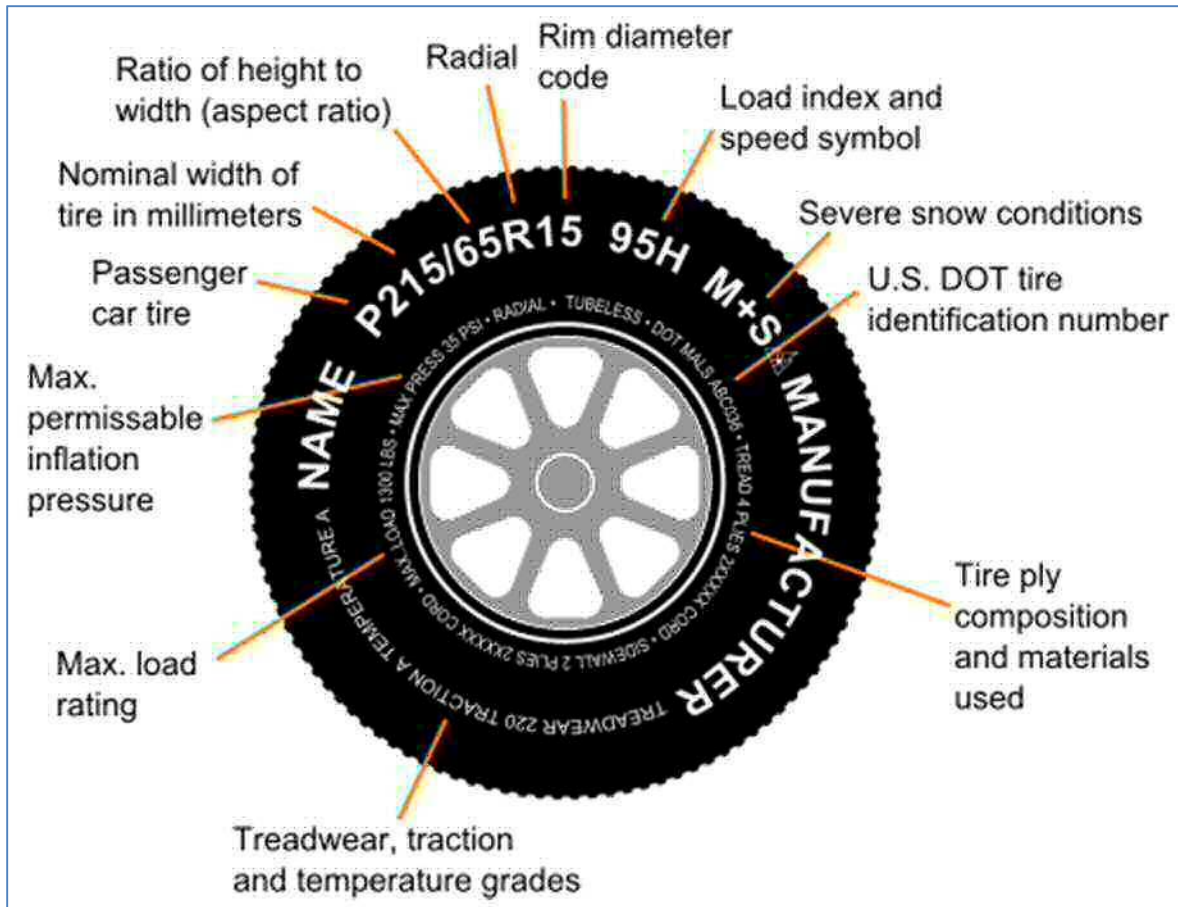

Tire manufacturer specifications on the tire wall which include various tire codes.

Image credit: CC-BY-Flanker on Wikipedia

Unless you become a tire technician, you don't have to know all the numbers on the tire or on the sticker/owner's manual because every time you get your tires replaced, the tire shop will make sure you at least have a tire that meets the required specifications.

Probably the most important number for the common person to recognize is the recommended tire pressure on the vehicle manufacturer's specifications on the driver's door jamb sticker. (The tire manufacturer's specifications on the tire itself include the maximum pressure that the tire can have, yet the maximum pressure isn't necessarily the best pressure for the vehicle).

How to Check the Tire Pressure

In order to check tire pressure you'll need a tire pressure gauge. Gauges can be purchased at auto parts stores and service stations (sometimes a little as \$1, but could be \$3-\$7). They're usually about the size of a large pen, but can come in other forms. Sometimes a gauge is included with the air hose of the air dispensing stand at the gas station.



Pen-sized tire pressure gauge



Air dispensing hose at a gas station with built-in pressure gauge



Round tire pressure gauge and hose

Follow these steps to check and correct the tire pressure:

- Remove the valve cap of each tire
- Align the gauge up to the valve
- Press the gauge onto the valve with firm direct pressure and then release. You'll see the measuring stick get pushed out of the other side of the gauge (on a pen gauge).
- Fill the tire with air, recheck the pressure, then repeat as needed until the desired pressure is obtained.
- Replace the valve cap

Tire pressure is measured in PSI (pounds per square inch) or KPA (Kilopascals) which are simply units of measurement for pressure. (Pressure is a force distributed over surface area)



Checking the tire pressure

Wheel Alignment

Tires can wear rapidly if they are not aligned properly, or the vehicle can pull to one side while driving. There are three angle measurements that are used in tire alignment: camber, toe, and caster. Knowing these angles is necessary for any tire technician. In addition, knowing these angles can be helpful for anyone trying to communicate with tire technicians.

In order to understand these angles one must consider the planes of the vehicle, which are ways of dividing the vehicle in each of its three dimensions (length, width and height). The horizontal plane, often depicted in math as the X plane, divides the vehicle into top and bottom parts. The vertical plane, often depicted in math as the Y plane, divides the vehicle into right and left parts (or driver's side and passenger side). A second vertical plane which intersects the first vertical plane at 90 degrees is often depicted in math as the Z plane, and it divides the vehicle into front and rear parts.

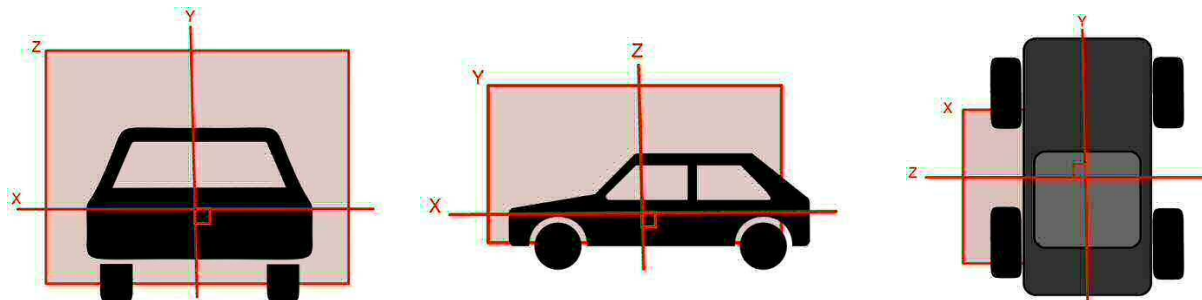

These three images show a model of a vehicle from the front, side and top views and the three dimensional planes that are used to describe tire alignment angles.

Images by Rex Kimball, www.MirexMarketing.com

The *camber angle* lies on the Z plane. (Imagine looking at the tires from the front of the vehicle). A camber angle of zero is when the wheel is vertical. If there is any camber, then the wheel is deviating from the vertical plane, or the Y plane. In many vehicles the camber should be zero, but some may deviate by 2-3 degrees.

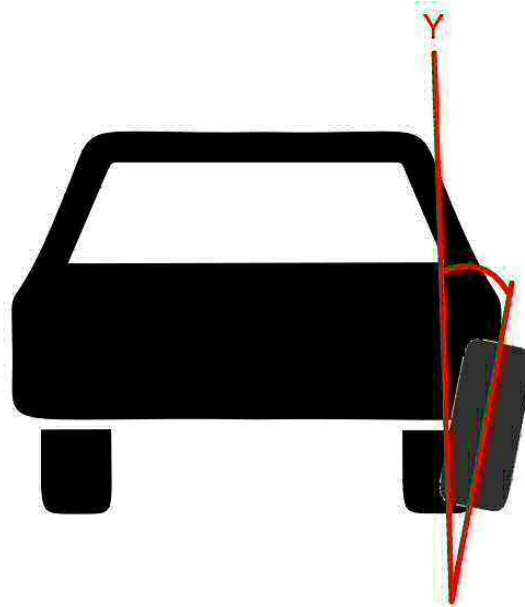

Image shows an outward camber. Notice how a tire in this alignment would wear quicker on the outside. If it had an inward camber then it would wear more on the inside of the tire
Image by Rex Kimball, www.MirexMarketing.com



A wheelchair with an inward camber as seen on many athletic wheelchairs.

The *toe angle* lies on the X plane and deviates from the Y and Z planes. (Imagine the vehicle from a bird's eye view or a top view). A toe angle of zero is when the wheels are

parallel on the Z and Y planes. This isn't quite how the wheels should be, at least not the front wheels. When thinking of toe, consider either the front wheels as a pair or the rear wheels as a pair. The distance between the front of each pair of wheels is measured and the rear of each pair (i.e. the distance between the front of the front wheels and the rear of the front wheels when considering the pair of front wheels). When the front wheels are properly aligned the front of the front wheels will actually be slightly closer together than the back of the front wheels, meaning the front wheels should have a slight inward toe. When the rear wheels are properly aligned they will be parallel (i.e. the distance between the front of the rear wheels is the same as the distance between the rear of the rear wheels).

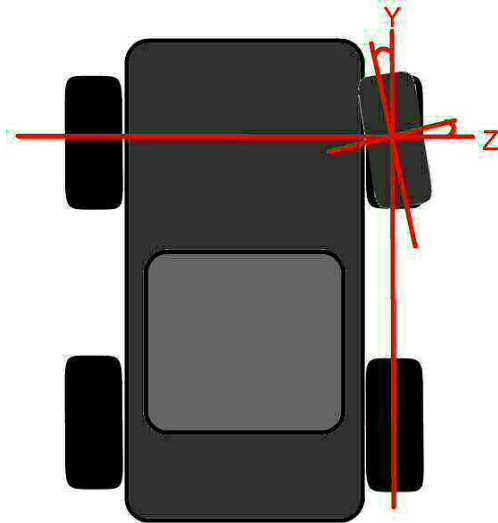
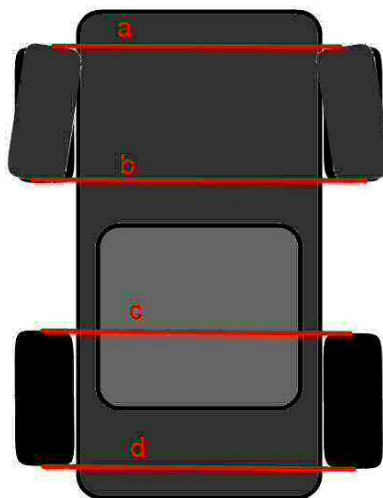

Image shows an inward toe of the front passenger tire.
Image by Rex Kimball, www.MirexMarketing.com



Measuring the distance between the front and back of the front tires as a pair and the rear tires as a pair. In this illustration, line a is shorter than line b, indicating an inward toe of one or both tires (both in this image). Lines c and d are equal in length, indicating a toe angle of zero.

Image by Rex Kimball, www.MirexMarketing.com

If a right wheel is turned inward while the left wheel is straight, or if both wheels are turned too far inward, or both are turned outward, etc., then there is an abnormal toe angle present and the wheels are not aligned. (Technically when you steer the vehicle and the front wheels turn to the left or right, they are deviating from the Y and Z planes, but they stay parallel to each other with only a slight variation to account for the fact that one wheel is on the outside and one is on the inside while turning).

The *caster angle* is an angle which lies on the Y plane and deviates from the Z plane. (Imagine looking at the vehicle from the side). Most devices with steering capability do not have a caster angle of zero. When the deviation is towards the rear, the caster is considered positive. When the deviation is towards the front, the caster is considered negative. On motor vehicles the caster is usually positive, (the higher ball joint will be closer to the rear than the lower ball joint). This helps the vehicle to drive straight even when the steering wheel is hands-free. Since the view of the caster is blocked by the wheel on vehicles with four wheels, it is most easily visible on motorcycles and bicycles. Think of the two braces that come down on both sides of the front wheel. Notice how the handlebars are closer to the rear than the center point (fulcrum) of the front wheel. This is a clearly visible positive caster. The front wheels of shopping carts have a negative caster. The physics of a negative caster allows for the front wheels to turn counter clockwise as the cart is turning clockwise so that the cart is easier to maneuver throughout the store.

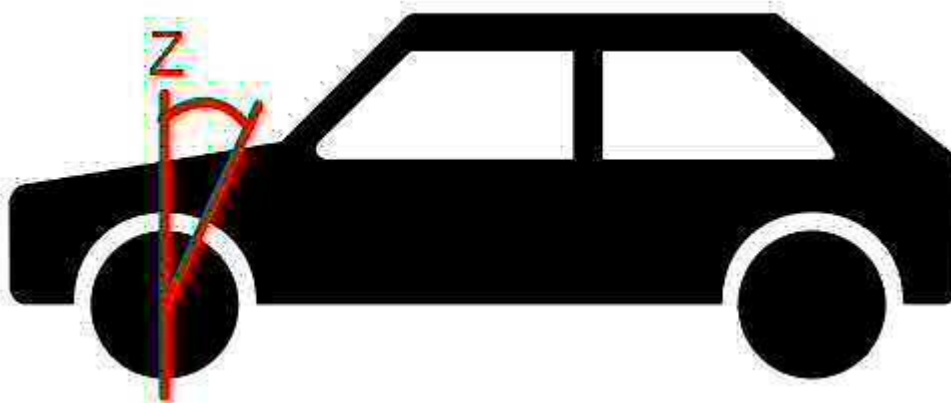
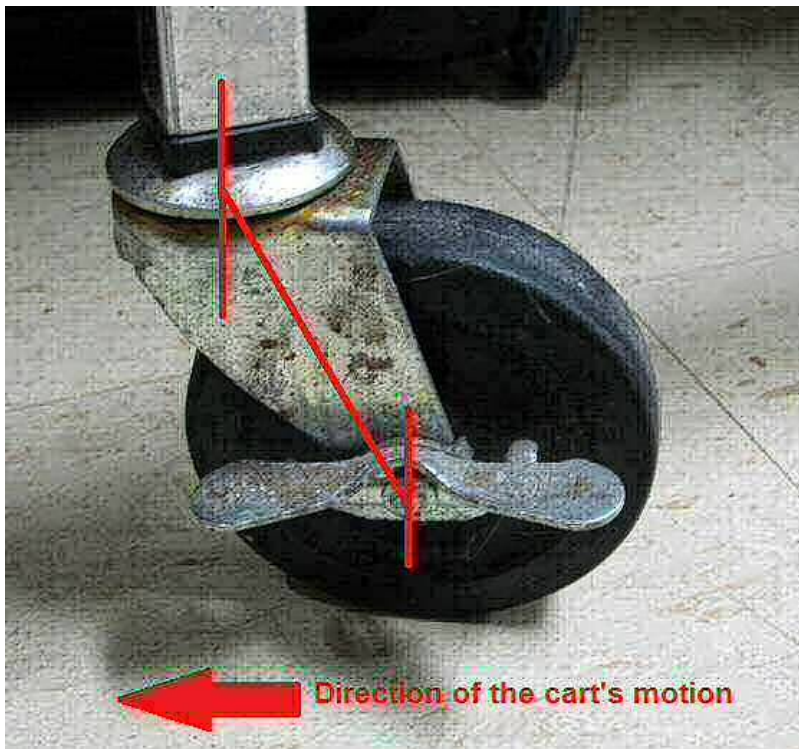

Image shows a positive caster. Motor vehicles have positive casters which help the vehicle drive straight even with a hands-free steering wheel.

Image by Rex Kimball, www.MirexMarketing.com



A positive caster is easily seen on the front wheels of motorcycles and bicycles.
Image adapted, original credit: CC-BY-SA-Yesterdays Antique Motorcycles on Wikipedia



Negative caster on a cart
Image adapted, original credit: CC-BY-SA-DMahlko on Wikipedia

Wear Bar

The wear bar is a horizontal bar molded into the tire between the treads. The wear bar indicates safe tread depth. It is usually about 1/16 of an inch measured from the valley of the tread, but not as high as the tread itself when the tire is new. As the tread wears down, the wear bar becomes more visible. When the tread is even with the wear bar the tires should be changed. Tires should be rotated with each oil change and kept in alignment to ensure even tread wear.



Tire with arrows pointing to the wear bars between the treads.

How to Change a Tire

Knowing how to change a tire is mostly helpful in case you get a flat while driving on the road. Every other time your tires get removed, rotated and/or replaced it will be by a tire technician.

Every vehicle has instructions for using the jack and other tools as necessary to change the tire. Some of the details can vary by make and model, such as the storage location for the jack and spare tire. Consult the owner's manual of the vehicle. Also, there will often be a sticker with instructions located with the jack and spare tire.



Standard spare tire kit with spare tire, lug wrench, and tire jack. This particular kit does not include chocks for the other tires. Notice how the spare tire is smaller than the regular tire. It is only meant to be used to get the vehicle to a repair shop.

Image credit: CC-BY-Kurt Nordstrom

Here are some general guidelines for changing a tire (in order):

- Make sure the vehicle is on level ground (see Chapter 1, Safety, proper lifting points)
- Apply the parking brake
- Remove the spare tire and tools from the vehicle
- Use wheel chocks to block the wheels opposite of the wheel you're changing (i.e. if you're changing a rear tire, then put the chocks in front of the front wheels).
 - Wheel chocks are similar to triangle-shaped door stoppers. When chocks are included with the tire changing kit, then they should be used. However, they are not present with every vehicle. Cases where they're not present may include vehicles with a rear parking brake and front wheel drive. When changing a rear wheel in these vehicles the front wheel drive keeps the vehicle stable, and when changing a front wheel in these vehicles the rear parking brake keeps the vehicle stable.
- Loosen the lug nuts before lifting the vehicle, but do not remove
- Pump or crank the jack to lift the vehicle using the proper lift points (see Chapter 1, Safety, proper lifting points)
- Remove the lug nuts
- Remove the flat tire
- Place the spare tire
- Replace the lug nuts snug
- Lower the vehicle

- Torque the lug nuts (tighten them as much as possible after the vehicle has been lowered)
- Replace the tools in the appropriate location for future use.
- Carry the flat full-size tire to the tire shop with you.

Spare tires are often smaller than the full-size tires that are regularly driven on. Spare tires are only meant to transport the vehicle to a tire shop when needed and should be changed as soon as possible. They should not be driven on regularly.

Tire Disposal

Any time you purchase a tire, the tire shop is responsible for charging a disposal fee and disposing the old tire properly. If for some reason you have to dispose of the tires yourself, you can take them to the city dump. The dump may charge you a fee. You can try taking it to a tire recycling facility where you might be able to dump them for free or even get paid for them.

Chapter 5: Internal Combustion Engines & Engine Oil

In this chapter you'll learn how an internal combustion engine works and the importance of engine oil.

How an internal combustion engine works:

All internal combustion engines operate on a theory called the Otto Cycle of events, named after Nikolaus Otto, who invented it in 1867. It occurs in 4 repeating steps or cycles:

- Intake
- Compression
- Combustion (or power)
- Exhaust

The fuel and air are drawn into the engine cylinder by the piston moving down while the intake valve is open. When the piston starts moving up, both intake and exhaust valves are closed. The piston moving up compresses the air and fuel mixture. The air and fuel mixture is then ignited with a spark plug (in regular gasoline engines), creating combustion. The extreme heat creates high pressure forcing the piston down. Next, the exhaust valve opens. The piston goes back up exhausting the exhaust gas. Then the cycle is repeated.

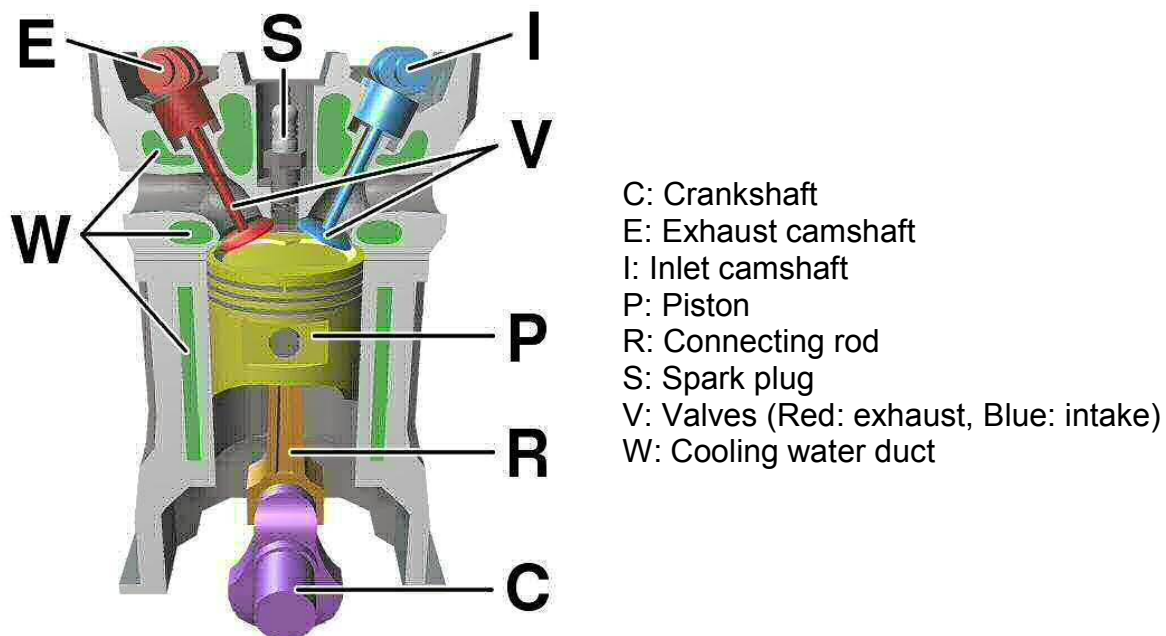

Cross section of a cylinder in a combustion engine.

Here is a decent animation of the Otto cycle on YouTube:

<http://www.youtube.com/watch?v=6qHherlwsTE>. (In the illustration above, the intake is on the right and the exhaust is on the left, but in the YouTube animation the intake is on the left and the exhaust is on the right)

The process of combustion is the conversion of chemical energy (gasoline) into heat energy (combustion) which is converted into reciprocating energy (pumping of the pistons). The pistons turn a crank shaft via a connecting rod. As the piston goes up and down during combustion it rotates the crankshaft. The crankshaft turns reciprocating energy into rotational energy. This energy is eventually transferred to the wheels through the drivetrain, which we will discuss later in Chapter 9.

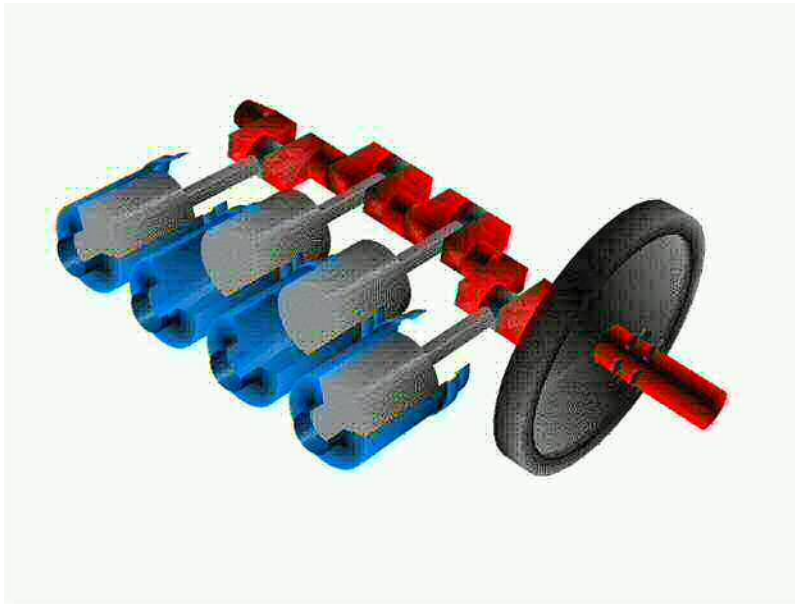

An illustration showing pistons (gray) in their respective cylinders (blue) and a crankshaft (red). As the pistons go up and down the crankshaft is rotated. This image is animated at <http://commons.wikimedia.org/wiki/File:Cshaft.gif>

In a diesel engine there are no spark plugs. The fuel is ignited based on compression alone. The compression is higher on a diesel engine, which generates enough heat to cause the combustion.

A hybrid vehicle uses an electric motor and battery for assisting propulsion along with the internal combustion engine. The internal combustion engine generates electricity to recharge the batteries. Also, the batteries are recharged when braking to a stop.

Engine Oil



Sample of motor oil

The purpose of engine oil is to form a film of lubrication between all moving parts of an internal combustion engine to reduce friction and wear. Choosing the right engine oil for your vehicle and changing the oil during regularly-scheduled maintenance intervals will keep the engine running smoothly over time. The recommended oil type and specification for your vehicle can be found in the owner's manual. Another place to find it is on the oil fill cap. It will be based on the ambient temperature where you live. There are two engine oil codes that the owner's manual will specify, an API and an SAE.

All oil has an API code which stands for American Petroleum Institute. It's a service rating for the quality, cleanliness, and types of detergents in the oil. The code will always be two letters.



The SAE is the viscosity or thickness of the oil. Modern oil is multi-viscosity oil. The SAE may be something to the effect of 5W-30. The first number-letter combo (5W) indicates the viscosity or thickness of the oil when it is cold. The second number is the viscosity at the engine operating temperature. Before they had multi-viscosity oil there was only single-viscosity oil (such as SAE 30), which in cold weather was extremely thick. Trying to pour it into your engine would be like pouring honey, but more importantly it would be hard to pump the oil and lubricate the engine. That's why older engines had to be warmed up before you could drive them.

Chapter 6: The Cooling System

This chapter is about the cooling system for the engine, not the air conditioning used to cool passengers while driving. A cooling system is needed to dissipate excess heat created during the internal combustion process.

Cooling system maintenance is preventive maintenance done to avoid an overheating situation and to avoid electrolysis (the breakdown of metals that occurs inside the engine block). Cooling system maintenance mileage varies by make and model. In some cases, maintenance is necessary before the mileage indicated in the owner's manual. For example, if the manufacturer recommendation is a coolant flush at 150,000 miles, it could easily need to be flushed before that. If the coolant is low then there may be a leak. Leaks can occur at the water pump, heater core, the hoses, radiator, and at multiple locations throughout the engine.

The coolant is inspected at every oil change (about every 5,000 miles) and when it is found to be dirty then a cooling system flush is necessary. Typically the coolant gets dirty when non-distilled water is mixed with it. The impurities in the water cause corrosion (breakdown of the metals in the engine), which collect with coolant. This can clog radiator and cooling passages. That is why coolant is mixed with distilled water where these impurities are absent.

When checking the coolant at home, be sure to never open the radiator while the engine is hot. (Remember Chapter 2: Checking Fluids).

How to flush the cooling system:

- Refer to the owner's manual for locations of each part of the cooling system
- Open the radiator drain to drain the cooling system and collect the drainage into a container (you can take this to your local auto parts store for recycling)
- Remove the thermostat. The thermostat is typically on the engine side of the upper radiator hose, but in some cases it's on the lower hose.
- Disconnect the lower radiator hose, force coolant through the thermostat housing (upper hose and engine block) with a garden hose until the water runs clear
- Connect the garden hose to the radiator, flush water through the radiator until the water runs clear.
- Completely drain the cooling system of all the water.
- Reinstall the thermostat
- Disconnect the reservoir and flush with the garden hose until water runs clear. Completely drain the reservoir.
- Connect the hoses and close the drains.
- Fill the cooling system with new coolant to manufacturer's specification and distilled water. Use a 50/50 mixture of coolant and distilled water or pre-mixed coolant.

Flushing the cooling system will not correct an overheating concern. If your vehicle is overheating, (as indicated on the temperature gauge on the dash), it would need to be diagnosed and repaired.

Any time you open the cooling system and put it back together you want to pressure test the cooling system to check for any leaks. You can use a pressure tester which can be rented from an auto parts store. It will come with instructions. Generally, it attaches to the radiator where the radiator cap goes, and you pump it by hand until the pressure on the gauge matches the pressure that is written on top of the radiator cap. Typically on a modern vehicle this pressure is between 13 - 16 psi. Let the vehicle sit with this pressure for 20 - 30 minutes. Then inspect the entire cooling system for any leaks and check the gauge for a change in pressure. If there is less pressure than before then there is probably a leak.





Pressure testing the cooling system

Chapter 7: The Fuel System

This chapter is about the fuel system. The fuel system is the system which pumps fuel into the cylinders of the internal combustion engine and mixes it with the perfect amount of air for combustion. There are two types of fuel systems: fuel injection and carburetors.

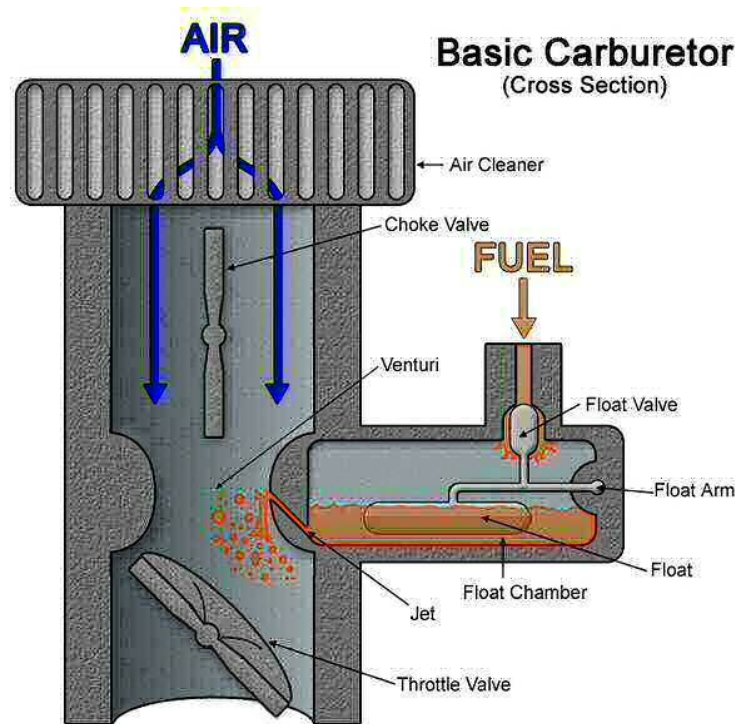

Illustration of a carburetor.
Image credit: CC-BY-SA-WikipedianProlific on Wikipedia

Prior to 1985 most vehicles used a carburetor. A carburetor uses a venturi (narrowed passage within the carburetor) to draw fuel from a float bowl based strictly on the volume of air flowing through the carburetor. A carburetor is a primitive method of mixing air and fuel. It is far less efficient than modern fuel injection. That's why all modern cars today are built with fuel injection.

How a Fuel Injection System Works:

Fuel injection is a complex electrical circuit using multiple sensors as inputs to a PCM (powertrain control module, also called the computer). The PCM then interprets the inputs from these sensors and produces a PWM (pulse width modulated) signal. A PWM signal is a digital on/off signal. This translates into how much fuel is injected into the engine.

The PCM then receives feedback signals from oxygen sensors. An oxygen sensor is a sensor that checks the air-fuel ratio by monitoring exhaust gas at or near the exhaust

manifolds (review Chapter 5 if needed). Using this information, the PCM can adjust fuel trim accordingly to keep the engine running clean, long and efficient. This is one of the main reasons newer automobiles last so much longer, burn less fuel, and have cleaner emissions.

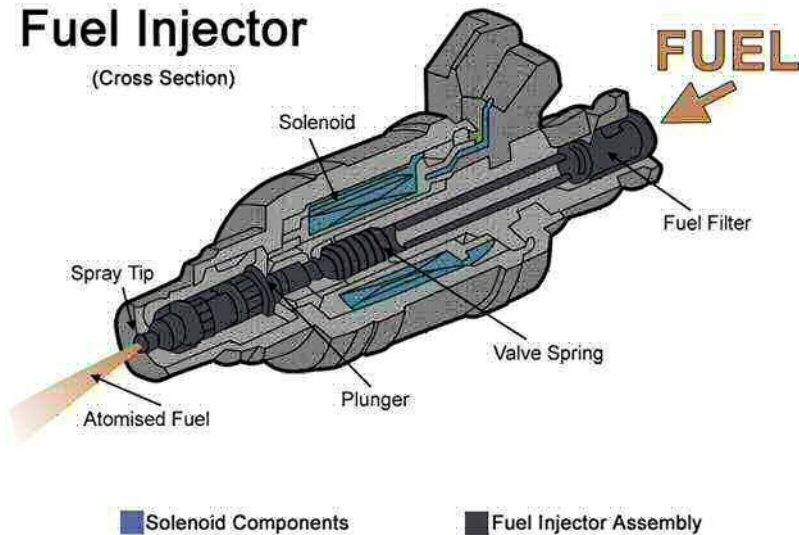

Illustration of a fuel injector.

Image credit: CC-BY-SA-WikipedianProlific on Wikipedia

Fuel Filter and Air Filter:

There are two filters which protect the fuel system and engine: the fuel filter and the air filter. The fuel system is very sensitive to contamination and debris. A small amount of contamination can cause severe problems in any fuel system. Therefore, these filters are critical for protecting the fuel system and engine.



A fuel filter (white) next to the air filter compartment (circular black part)

Image credit: CC-BY-Phasmatisnox on Wikipedia

When you fill your vehicle with fuel from a gas station, the fuel will have contaminants. Between the fuel tank and the engine the fuel passes through a sock filter which prevents large contaminants from passing through. Then the fuel will pass through the fuel filter which prevents small contaminants from passing. Anything that passes through the fuel filter can pass through the rest of the fuel system. Refer to the owner's manual to find the manufacturer's recommendation for the mileage at which the fuel filter should be changed.

An air filter protects the engine from dust and dirt entering the combustion chamber through the air intake system. Any dirt in the engine can cause engine wear and eventually lead to engine failure. Therefore, an air filter, like the fuel filter, is also a critical component in any internal combustion engine. The air filter is inspected with every oil change and it is changed as needed. (The air filter was also mentioned in Chapter 2 since checking it is part of general maintenance).



Various air filters.

Image credit: CC-BY-SA- Maly LOlek on Wikipedia

Chapter 8: The Electrical System

This chapter is about the electrical system of the vehicle. The main parts of the electrical system are the battery, alternator, and ignition system. The battery is the power source of the whole vehicle. The alternator is a re-charging device which is used to maintain the charge of the battery. The ignition system is used to ignite the fuel at the correct time during the Otto cycle of events (review Chapter 5 for the Otto cycle of events).



Alternator

Image credit: CC-BY-SA-Lolossos on Wikipedia



Car Battery

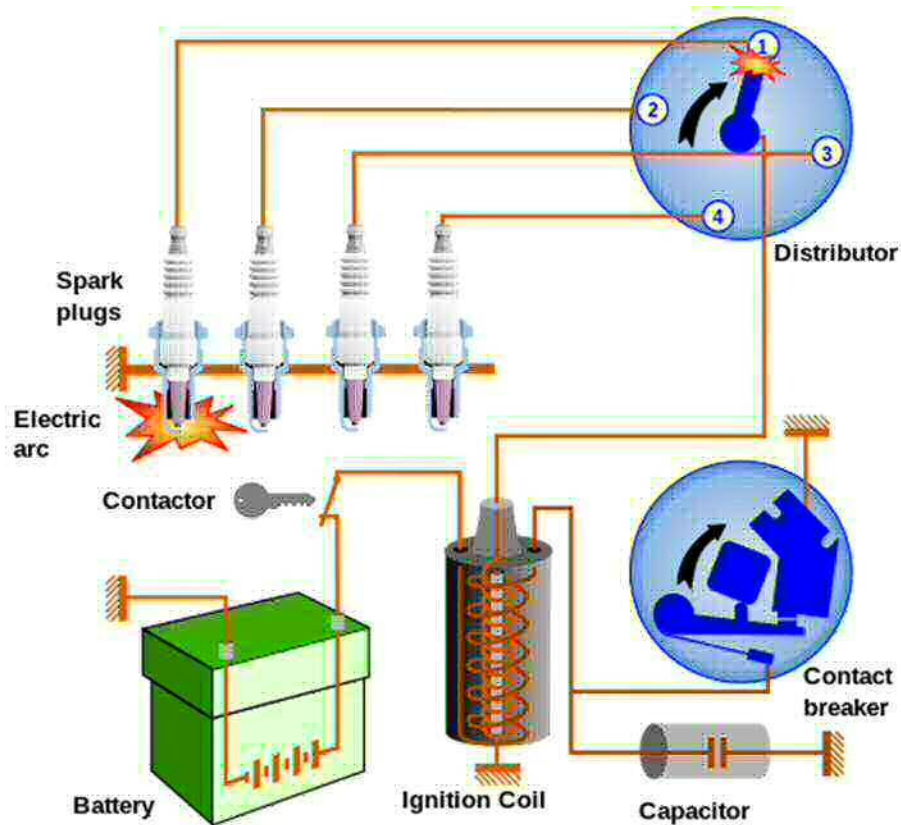

Ignition System (prior to 1975)

Image credit: CC-BY-SA-Allumage_batterie on Wikipedia

The "ignition" in this lesson is not the same as the key ignition; it's about the ignition system that is used in the engine to ignite the air-fuel mixture in the combustion chamber. Prior to 1975, the ignition system consisted of the ignition coil, capacitor, contact breaker, distributor and spark plugs. The ignition coil converts low voltage electricity into high voltage. The high voltage electricity is sent to the distributor through the rotor, then it transmits out the distributor cap through plug wires to the spark plugs. The contact breaker or contact points complete and interrupt the circuit to the ignition coil on the low voltage side. The capacitor absorbs a voltage spike when the points open to avoid burning the contacts of the points.

In a modern vehicle the ignition system consists of a crankshaft position sensor, which sends a signal to the PCM (powertrain control module or computer). The PCM interprets the signal and sends a signal to the ignition coils on each cylinder. Then the ignition coils fire through the spark plugs. Some vehicles will use one coil for two cylinders, and some have a separate coil for each cylinder. When one coil is used for two cylinders, the spark plugs for both cylinders fire at the same time, but one of the cylinders will be in the exhaust step of the Otto cycle, so it's kind of a waste spark (not used to ignite fuel).

The ignition system works in conjunction with fuel injection (Chapter 7) so that the correct Otto Cycle of events occurs in the cylinders. The cylinders of internal combustion engines are numbered and the firing sequence occurs in a specific order. The firing order can vary by vehicle make and model. The engine size is also a factor.

For example, in an 8 cylinder Chevy engine the cylinders might be numbered 1, 3, 5, 7 on the driver's side (or left side of the engine from the driver's perspective), and 2, 4, 6, 8 on the passenger side. The firing order for this particular engine would be 1, 8, 4, 3, 6, 5, 7, 2.

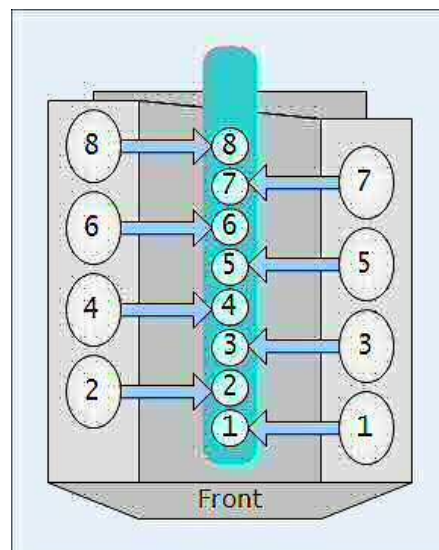

Illustration of numbered cylinders of a V8 engine; the driver's side is the right side of this image since the front of the engine is towards the bottom of the image.

Spark Plug Gap:

The purpose of the spark plug gap is to create an electric arc or spark of high heat to ignite the air-fuel mixture in the combustion chamber at the correct time. If the gap is too small then the spark is not hot enough to ignite the fuel. If the gap is too wide, then the voltage is not high enough to create a spark. Either condition can create an ignition misfire, causing poor performance and high emissions.

How to Safely Jump Start a Vehicle with a Failed Battery:

When a battery loses its charge the vehicle won't start and it becomes necessary to use another vehicle for a jump start. Since jump starting a failed battery with a charged battery involves creating an electrical circuit, it is important to follow the right steps to perform a jump start safely:

- Do your best to line up the vehicles so that the two batteries are close enough to connect jumper cables.
- Turn off the active vehicle
- Verify there is no odor (like sulfur) coming from either battery. If there is a sulfur odor do not attempt to jump start the vehicle. The battery could explode due to the gas that is released (hydrogen gas).
- The next steps involve connecting the cables. When connecting cables to the first vehicle, which is the dead vehicle, make sure the other ends of the cables are not touching each other.
- First connect the red cable to the positive (red) battery terminal on the dead battery or to the jump start locations specified in the owner's manual.
- Connect the black cable to the negative terminal of the dead battery or to the jump start locations specified in the owner's manual.
- Connect the positive (red) cable to the positive terminal of the working vehicle (or to the specified jump start location in the owner's manual of the working vehicle).
- Connect the negative (black) cable to the negative terminal of the working vehicle (or to the specified jump start location in the owner's manual of the working vehicle) or to anything metal. The metal must be bare or without any paint that would inhibit conduction of electricity. The engine block is sufficient. Yet, the negative terminal is often the most accessible.
 - (More briefly the order is: dead red, dead black, live red, then live black. Red is always positive, black is always negative.)
- Start the working vehicle and allow it to run for approximately 5 minutes.
- Attempt to start the other vehicle. If the vehicle fails to start, there may be additional problems or the battery is no longer rechargeable.
- Take off the cables in reverse order (always remove negative first) and make sure the cables don't touch each other as you're removing them
 - Remove the negative cable from the jumped vehicle
 - Remove the positive cable from the jumped vehicle (make sure they don't touch each other)
 - Remove the negative cable from the previously working vehicle
 - Remove the positive cable from the previously working vehicle.

That may seem like a lot of steps above to memorize, so here are some tricks to remember the process: *first connect the Dead Red, Fred*. This phrase will help you remember that when connecting the cables you'll start with the positive cable on the dead battery. The order is dead red, dead black, live red, live black. Then it's the reverse order to remove the cables after the dead battery is jumped: *First remove the Jumped Black, Jack*. Remove the jumped black, jumped red, then the previously live black, then the previously live red.

Never attempt to jump start a diesel vehicle. Since a diesel engine battery requires much more power, attempting to jump start it could damage the running vehicle.

Typically you can attempt to jump start a hybrid car, but if the high power battery is dead, the vehicle will not start. However, a hybrid can be used to jump start a regular gasoline vehicle.

Chapter 9: The Drive Train

The drive train (drivetrain or powertrain) is a series of parts that transfer energy from the combustion engine to the wheels. If needed, review Chapter 5 to recall how the internal combustion engine works to convert chemical energy to rotational energy. The drive train has three main parts: the transmission, drive line or drive shaft, and differential. In some four-wheel drive vehicles a transfer case is also necessary.



Powertrain for a Subaru vehicle. The engine and transmission are seen on the right. The drive shaft is in the middle and the differential is on the left at the center of the rear axle.

The rotation of the crankshaft in the internal combustion engine does not equal the rotation of the wheels. Just like a bicycle, motor vehicles have gears. The lower gears are used for lower speeds, while the higher gears are used for higher speeds. Yet, the RPM which is read on the dashboard tachometer may be relatively constant (or stay within a range) through all speeds. The transmission, which is where the actual gears are located, takes an input speed from the crankshaft and reduces it to the output speed until the vehicle is in "direct" drive. In other words, it changes the gear ratios. So, in first gear you might have an input to output ratio of 4 to 1. This means that as the input shaft goes around four times, the output shaft goes around one time. At 4,000 RPMs input you would have 1,000 RPMs output. Second gear may have a 3 to 1 ratio and third gear a 2 to 1 ratio. Fourth gear would be direct drive with a 1 to 1 ratio.

Think of the sprockets on a bicycle. There is a large sprocket on the front that rotates as the bike is pedaled, and there are also large and small sprockets on the back wheel with a chain that connects the front sprocket to the rear sprockets. As the gears are changed, so is the mechanical advantage for the person that is pedaling.

In direct drive, the input speed and the output speed are the same; there is no gear reduction. Modern vehicles have overdrive, which is a ratio of 0.75 to 1. This means that the input speed is less than the output speed, which results in better fuel economy on modern vehicles.

These numbers and ratios are used to present the general idea. Every vehicle has its own input to output ratios.

The drive line (or drive shaft) is a round tube that transfers power from the transmission to a differential. It is situated longitudinally underneath the car. A front-wheel drive vehicle won't have a drive shaft. Some four-wheel drive vehicles have more than one drive shaft.

A differential (aka rear differential in rear-wheel drive vehicles, rear end, or part of the rear axle) has hypoid gears. These are specialized gears which transmit the rotation of the drive shaft 90 degrees in order to turn the axles and correlating wheels and tires. There are spider gears inside the center section of the differential that allow the wheels to travel different distances while turning. Consider a car that is turning right. The driver's side rear wheel travels a farther distance than the passenger side rear wheel. Think of using a protractor to draw a circle. One leg of the protractor simply rotates on one center spot, while the other leg draws the circle. While the rear wheels of a vehicle don't turn as sharply as a protractor, the principle is the same.

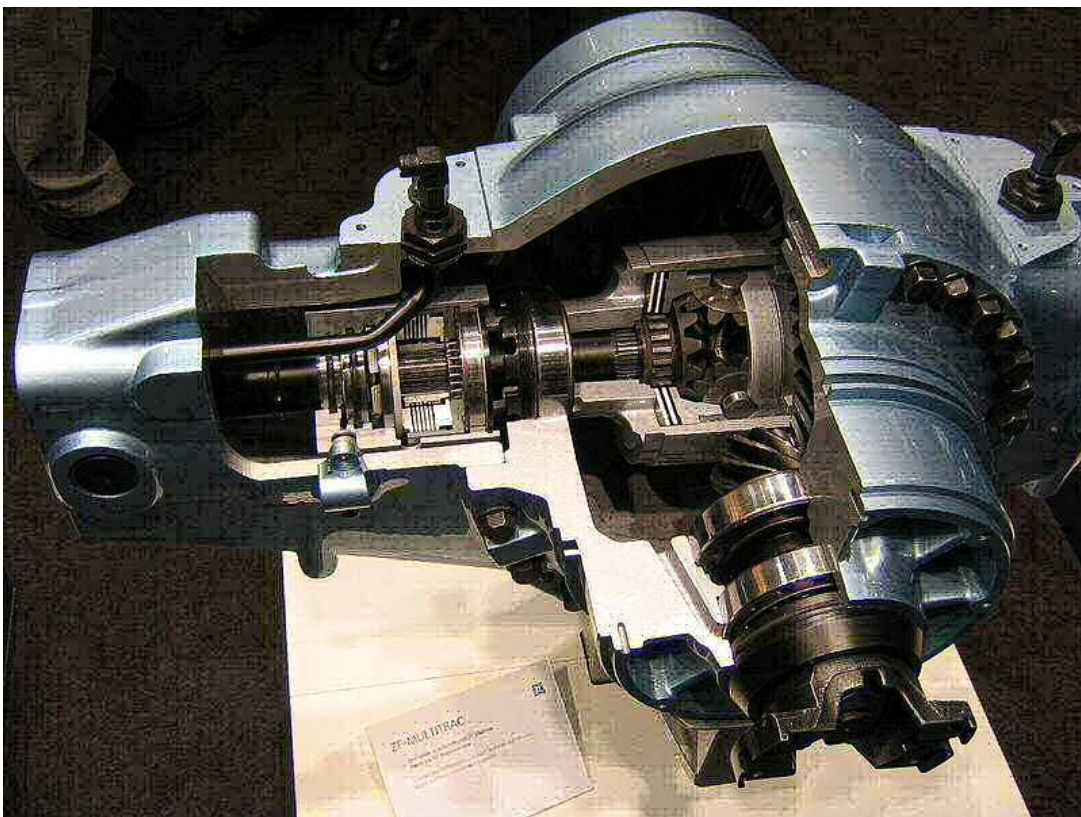

A differential for a German vehicle with cutout to see the inside.
Image credit: CC-BY-SA-Aconcagua on Wikipedia

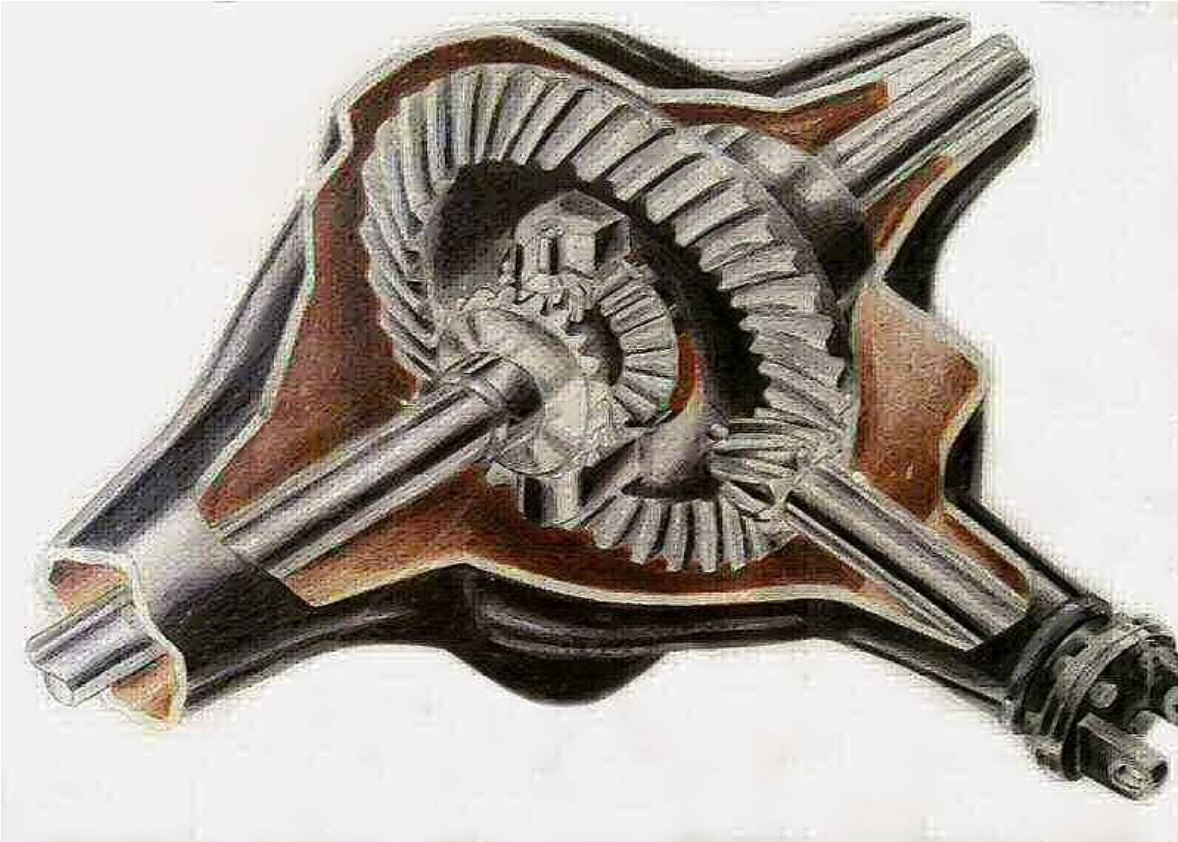

An illustration of a differential which shows how the gears can be used to change the direction of the rotation. The drive shaft is on the lower right corner of the image. The top right and lower left of the image show the rear axle which extends to the rear wheels.

Image credit: CC-BY-SA-17177 on Wikipedia

The Difference Between a Manual and Automatic Transmission:

A manual transmission (which is also called a standard transmission) uses conventional gears. All of these gears are turning at all times when the engine is running and the clutch is released. When a gear is selected with the gear shift, the gear is being attached to the output shaft. Then to change gears, the clutch is depressed and the next gear is selected which attaches that gear to the output shaft. The gears are manually selected.

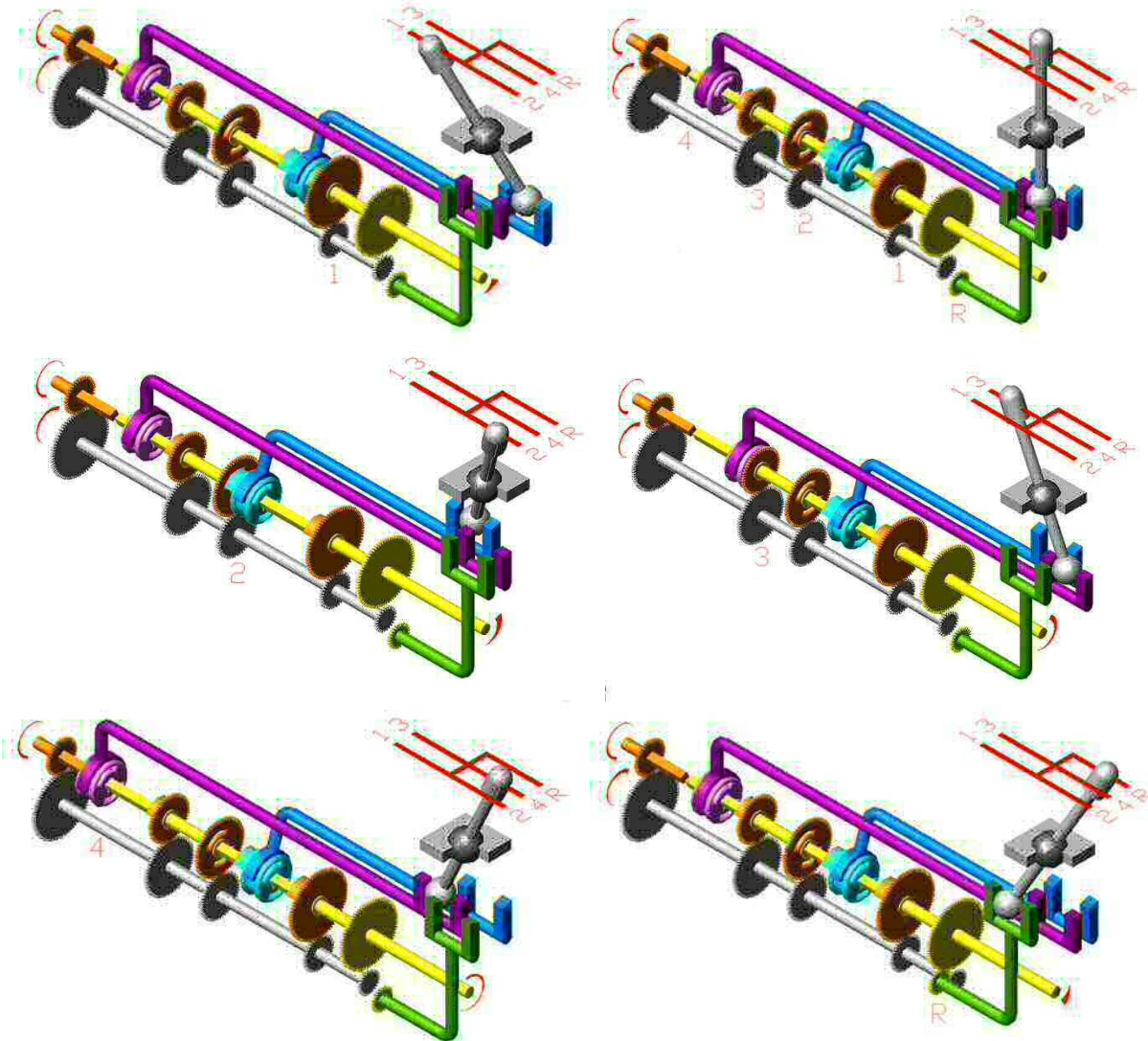

Illustration of a manual transmission.

An automatic transmission uses “sun and planet” gears. A “sun and planet” gear set has a central “sun” gear with “planetary” gears (typically three or four) located around the “sun” gear. These gears can rotate, turn or hold to create different speeds and directions. To select the gears there are multiple clutch packs and/or bands that are hydraulically applied by a valve body to control gear selection.

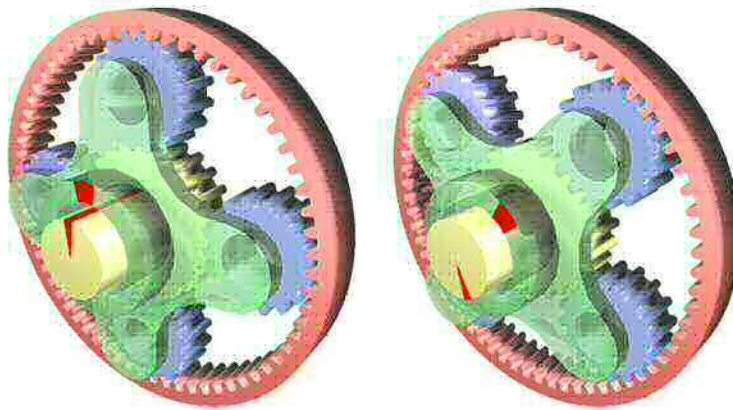

Illustration of sun and planet gears in an automatic transmission. The yellow gear in the illustration is the “sun” gear and the four violet gears surrounding the sun gear are the “planet” gears.

Image credit: CC-BY-SA-Wapcaplet on Wikipedia

Types of Automatic Transmission Fluid:

There are 30 or more different types of transmission fluid for today's modern vehicles. All the fluids look the same. Refer to the owner's manual to select the correct fluid. Aftermarket suppliers make fluids that are compatible with multiple different vehicles. When choosing aftermarket fluids, be sure that the specified fluid in the owner's manual is listed on the aftermarket bottle.

Lubricants Used in Standard Transmission:

The lubricants used in a standard (or manual) transmission on modern vehicles have multiple types of fluid. Be sure that the fluid installed in the vehicle meets the manufacturer's specifications.

Lubricants Used in Differentials:

Most differentials use conventional 80-90 gear oil. The 80-90 numbers indicate the weight and viscosity of the oil. (These are similar to the API and SAE discussed in Chapter 5). Some vehicles require special fluids. Be sure the fluid meets the manufacturer's specifications. Limited slip differentials may require an additional additive.

The Difference Between Front Wheel Drive, Rear Wheel Drive & Four Wheel Drive:

The main differences between front wheel, rear wheel, and four wheel drive are the position of the drive train parts and where the drive train transmits the energy.

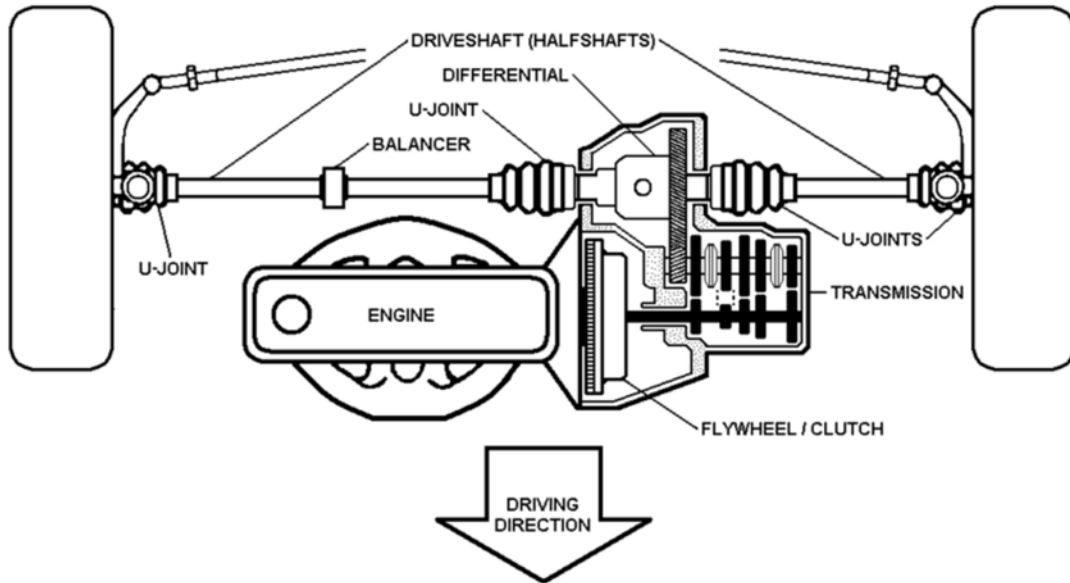
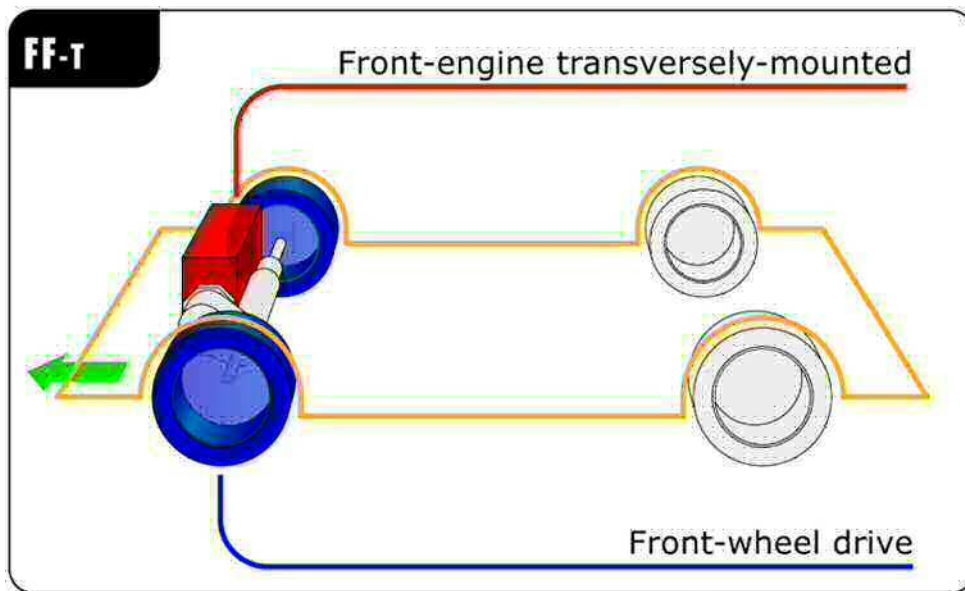
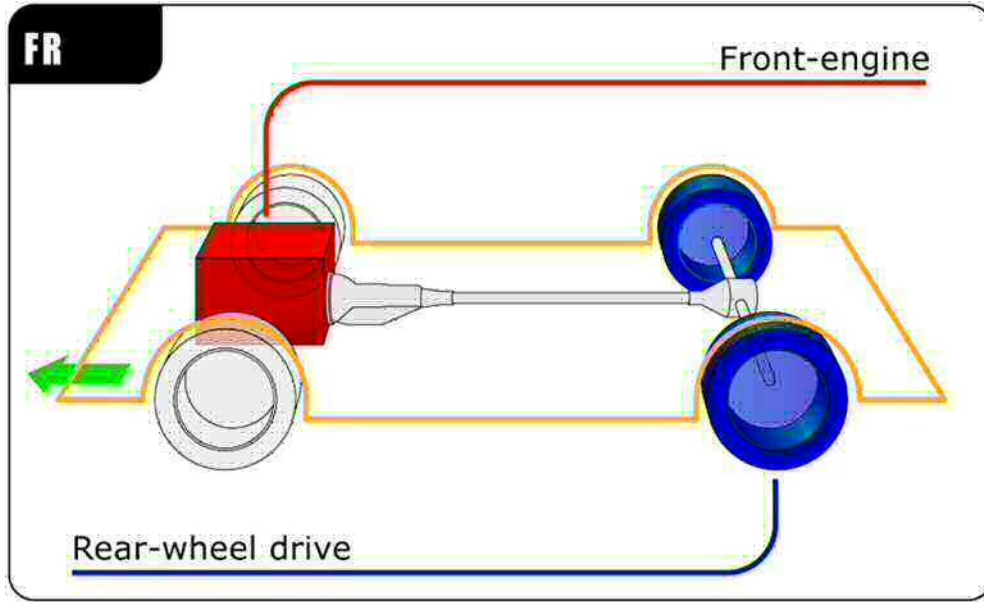

Illustration of a transaxle which has a transmission and a differential
 Image credit: CC-BY-SA-Hoikka1 on Wikipedia



Front-wheel drive
 Includes engine (red), and transaxle.
 Image credit: CC-BY-SA- Moebiusuibeom-en on Wikipedia

A front wheel drive vehicle incorporates a differential and a transmission into one piece, called a transaxle. The transaxle transmits power from the engine to the front wheels.



Rear-wheel drive
Includes engine (red), transmission, drive shaft, and rear differential.
Image credit: CC-BY-SA- Moebiusuibeom-en on Wikipedia

A rear wheel drive vehicle transmits engine power through a transmission to the drive shaft, and then to a differential in the rear of the vehicle.

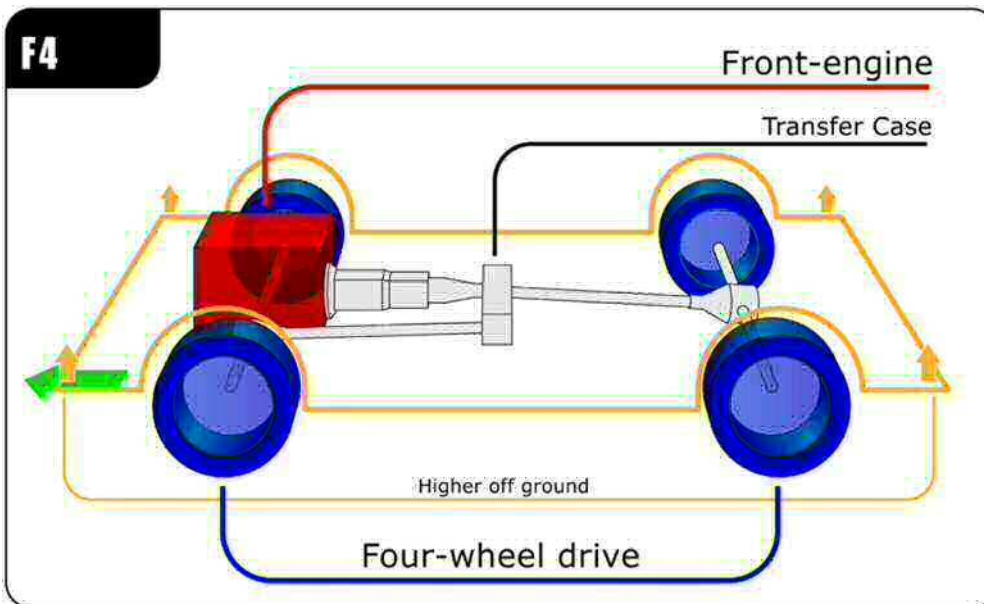

Four-wheel drive
Includes engine (red), transmission, transfer case, front & rear drive lines, and front & rear differentials.
Image credit: CC-BY-SA- Moebiusuibeom-en on Wikipedia

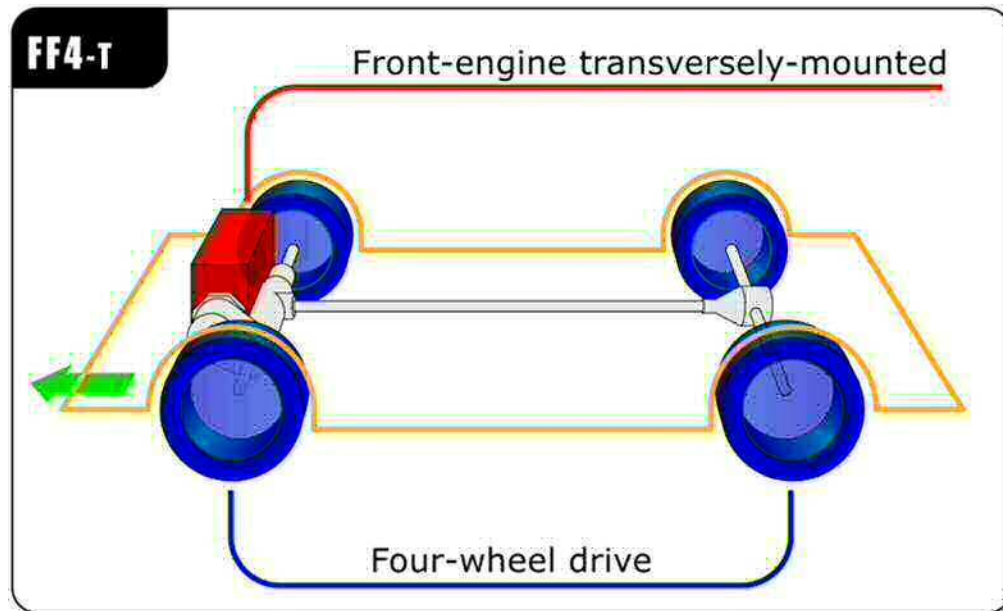

Alternate four-wheel drive

Includes engine (red), front transaxle, drive line, and rear differential.

Image credit: CC-BY-SA- Moebiusuibeom-en on Wikipedia

One type of four wheel drive vehicle transmits power through a transmission, and then to a transfer case, which distributes the power through the front and rear drive shafts, then to the front and rear differentials. Another type of four wheel drive has a front transaxle and rear differential.

(The diagrams in this book are not the only configurations. A vehicle can have a rear engine with all three drive types, or even a mid-mounted engine.)

Chapter 10: Brakes

Brakes offer a way to slow the momentum of a vehicle for better control and safety on the road. A brake system uses hydraulic advantage to apply force to a friction material that generates heat. A moving vehicle has kinetic energy. Brakes convert kinetic energy into heat energy.

There are two types of brakes: disc brakes and drum brakes. The main differences are the shapes of the brakes and their friction material. Friction material provides the buffer that prevents metal from grinding when the brakes are applied. It can withstand the heat that is generated, although it wears out over time and has to be replaced many times throughout the life of the vehicle.

Disc brakes have a rotor (disc) for each wheel and brake pads are the friction material. A brake caliper applies force to a brake pad, which presses it against the rotor when it is applied. This generates heat and stops the vehicle.



A disc brake. The rotor is the shiny gold-colored disc and the caliper is red. The black piece between the caliper and the rotor is the pad.

Image credit: CC-BY-SA-David Monniaux



Disc brake pads. They're red in this image. They can be any color.

Image credit: CC-BY-SA-Treemonster86 on Wikipedia

Drum brakes are shaped like a drum and brake shoes are the friction material. A wheel cylinder applies pressure to a brake shoe with a friction lining. Think of a circle within a circle. A hydraulic device expands the shape of the shoes to press against the drum. This generates heat and stops the vehicle.

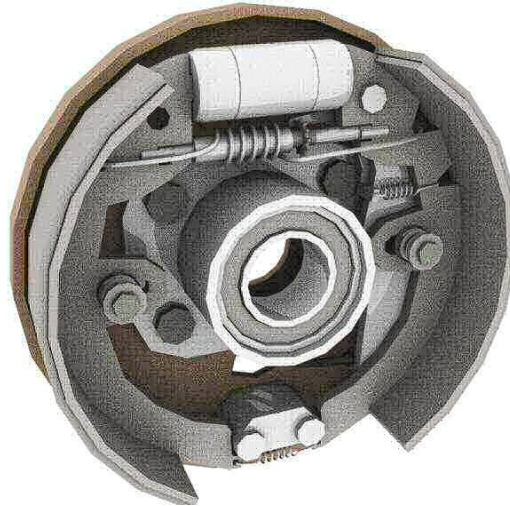

Illustration of a drum brake

Image credit: CC-BY-SA-Wapcaplet on Wikipedia



Drum brake shoes (violet color) and linings.

Image credit: CC-BY-SA-Maly LOLEk on Wikipedia

The master cylinder is a hydraulic cylinder that is used to apply force to the brake calipers and/or wheel cylinders. The wheel cylinders (used in drum brakes) and the brake calipers (used in disc brakes) are both “hydraulic slave cylinders”.

Anti-lock brakes have complex electrical and hydraulic components which are used to avoid skidding wheels in a panic stop or in a poor traction condition. The anti-lock brakes (ABS) use signals from each wheel speed sensor to determine if one wheel is

stopping faster than any of the others. If this occurs, the ABS control module (a computer) will signal the ABS hydraulic control unit to isolate that wheel, release brake pressure, and then pulsates the brake pressure to maintain equal speeds of all four wheels. This helps avoid skidding and maintains maneuverability during a panic stop.

How to Check the Brake System:

The brake system is often checked by the mechanic during routine oil changes and maintenance. However, it can also be checked at home. Consult the service manual of the specific make and model about checking the brakes and finding the locations of each part of the brake system. Follow these steps to check the brake system:

- Start under the hood.
- Check the brake master cylinder for leaks.
- Check the level and condition of the brake fluid.
- Inspect all lines and the anti-lock brake module for leaks or loose, damaged connectors.
- Raise the vehicle and support it securely on a lift or jack stands (review Lesson 1 if needed)
- Remove all four wheels
- If the vehicle has drum brakes, then remove the drums.
- Inspect all brake lines and hoses for signs of leaking or cracking
- Inspect the caliper hardware and dust boots for damage
- Inspect the caliper (or wheel cylinders) for brake fluid leaking.
- Inspect the rotors for smoothness. If a rotor has any pits or grooves then it will have to be reconditioned or replaced.
- Check the thickness of all the brake pads.

If there is any variation in the brake pad (or shoe) thickness between the driver side and passenger side, then there may be an adjustment problem, a defective caliper or other defective hardware. Usually the front brakes wear faster since the front brakes are responsible for about 80% of the stopping. There is no blanket measurement for brake pad thickness since the thickness of new pads can vary by make and model of the vehicle. A few millimeters could appear brand new in one car but be an indication for pad replacement in another. If the thickness of the pad is 20% of the original thickness or less, then the pads should be replaced. The original thickness can be found in the service manual for the vehicle.

Chapter 11: The Auto Repair Industry

Consumers should be aware of how the auto repair industry works. When you bring your vehicle to an auto repair shop and enter the office, you're usually greeted by a service writer. It doesn't matter if you go to a dealership, a franchised shop (like Midas or Firestone), or a small independent shop -- more often than not, the service writer is the first person you meet. The service writer acts as an intermediary between you and the repair technician. He tells the technician to inspect the car, the technician informs him what the findings are, and then he comes back to you with the findings. Some shops allow the customer to come into the repair room to see the technician's findings, but many don't.

The service writer is evaluated by upper management, which may include the manager of the shop, a director of one or many shops, and/or the owner. The owners of large shops are not usually onsite and function mostly as investors. They're hoping to make a return on their investment. Directors may manage multiple shops or be the head of an entire department, such as the service department at a dealership.

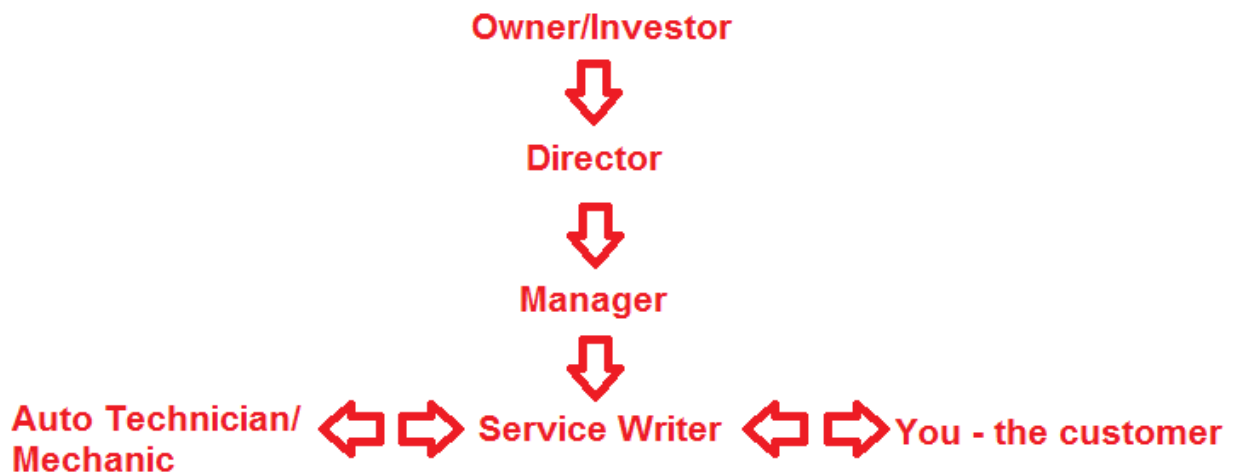

Illustration of how the auto repair industry is organized

Since the service writer is a middleman between the customer and the technician, there are frequent communication problems that can occur. A customer may come into the shop and say that the car makes a squeaking sound when the brakes are applied. The service writer thinks it's the brake pads, so he tells the technician to inspect the brake pads. There may be nothing wrong with the brake pads. What the service writer should have done is write down that there is a squeaking sound when the brakes are applied. Then the technician can diagnose the problem better. Similar communication issues can also occur in the other direction. The technician may explain problems or findings to the service writer and the service writer may fail to relay the information correctly to the customer.

The service writer is first and foremost a salesman, not a technician. His knowledge and understanding of how a vehicle works is often not any greater than the customer's. Some service writers can be very knowledgeable about cars; others are not. In either case, when the customer speaks to him, he will appear to understand what is wrong with the vehicle.

A major problem with the entire industry, from the technicians to upper management, is that everyone is paid on commission. This means that they are motivated and rewarded to increase sales and raise the price in order to make more money. The services that they suggest are often not damaging to the car; they're just not necessary. They may say that your cooling system needs a flush when it doesn't or they could fudge the numbers on maintenance intervals to increase the frequency of services. Maintenance services are often based on mileage, so it's easy for a shop to say that a service is required at 30,000 miles when it actually isn't due until 90,000 miles. By changing the interval to every 30,000 miles, they sell the service three times instead of one. This is why it is important to review the maintenance chart in the owner's manual of the vehicle. Also, some repairs are needed at an earlier time than what is specified in the owner's manual. This will be based on certain conditions which can include the weather, the driving route, the driver's habits, and other environmental conditions where the vehicle is driven or parked on a regular basis.

Auto dealerships generally have a service department and a sales department which are run as two separate businesses. The sales department is actually a customer to the service department. The sales department is responsible for moving inventory (selling cars on the lot). The service department is responsible for providing services which include inspections, maintenance and repairs. The sales department is a customer to the service department because every vehicle has to be inspected and serviced before it can be sold. Since the service writer is still paid by commission even when ordering services for the same dealership, he can often tell the sales department that a particular vehicle can't be placed out on the lot unless it receives all the top services. Since the sales department wants to sell the vehicle, they have no other choice than to accept the services and pass the additional costs on to the customer. The service department is the one that determines whether a vehicle can be put on the lot, not the sales department. This arrangement can be a safeguard for the vehicles being sold and add protection to buyers. However, it also gives the services writers more control and it is often used to increase commissions.

When people take their cars to the dealership for maintenance, they are often under the impression that the dealership has a certified technician performing the repairs. Often the technicians are just kids out of high school with little training or experience. These entry level employees are often called "lube techs" because traditionally the job only involves changing the oil. However, today some dealerships allow lube techs to perform any repair that they feel comfortable doing, even if they weren't specifically trained for it. This saves the dealership money because the lube techs aren't paid as much as the certified technicians.



Illustration of Auto Dealership organization

Some shops are sincerely honest, and they do their best to provide good service. Yet, the system is still flawed. The staff is still paid by commission and the communication gap can still exist between the customer and the repair technician due to the presence of the middleman service writer.

At Crawford's Auto Repair, we have a completely different system of management. The owners are the technicians and they don't get paid by commission. There are no service writers. Customers have direct interaction with the technician, who inspects the vehicle. An honest and accurate estimate is given to each customer. The technician only performs the repairs after receiving permission from the customer and customers are always welcome into the repair room to observe the inspections and repairs. Also, we never try to sell unnecessary repairs or services.



Illustration of Crawford's Auto Repair organization - no service writer, no commissions, no unnecessary services or fees.

This book is provided to all auto repair consumers free of charge to help them gain a better understanding of their vehicle and the auto industry in order to save money. If you've enjoyed this book, and if you're within a reasonable driving distance of our shop, then come try us out.

We're located at 2855 S Alma School Rd, Mesa, Arizona 85210.

Visit our website at www.CrawfordsAutoService.com or call us at 480-201-0740.

Our website and blog have more information on auto maintenance and repair.

Chapter 12: How to Buy a Car

By contributing author Rex Kimball

Buying a big-ticket item, like a vehicle, can be daunting, especially if the buyer doesn't know where to start. This chapter offers a beginner's guide to buying a vehicle. Yet, when it comes to buying a vehicle, serious buyers will go beyond the steps described here. For example, this chapter may mention the art of negotiation, yet entire books have been written on the subject of negotiating, and increasing one's skill in negotiation will help the buyer to get a better deal.

One of the most important things for potential car buyers to know is that the majority of vehicles depreciate in value over time. If you purchase a new or used vehicle from a dealership, the vehicle depreciates by about 20% of the sale price the minute it is driven off the lot. That means that if you turned around and sold the vehicle within a week, you'd probably only be able to sell it for about 20% less than you paid for it. It's not like buying a house where the property generally increases in value over time (except during economic decline). Vehicles are not investments; they're simply a necessary expense in locations that don't have good public transportation as an alternative. (They could be investments if you get involved in the collector's market, which is an entirely different game).

It is also important to realize that the cost in owning a vehicle is much more than simply the sales price of the vehicle. All expenses must be considered before accepting the burden on your monthly budget. The sales price of the vehicle is just the beginning. If you're taking out a loan to pay for the vehicle then you'll first have the monthly loan payment.

You'll also have to pay for gas to run the vehicle. The price of gas varies from week to week and by location. Wednesday is probably the best day of the week to buy gas. You also don't want to fill up while the service truck is at the gas station refilling the storage tanks. When they refill the tanks there are contaminants at the bottom that get stirred up and these contaminants can come through the gas pumps and into your vehicle. Granted, you learned about the fuel filter in Chapter 7, but there is no sense in wearing it out sooner than you have to. Go to www.MapQuest.com and click on "gas prices" to find the best gas prices in your area. The amount of gas that you have to purchase from week to week will depend on how much you drive and the gas mileage of the vehicle that you purchase.

Gas mileage is calculated by the change in mileage divided by gallons used (or miles per gallon, MPG). The next time you go to the gas station to refuel, fill the gas tank to full and write down the mileage that appears on your odometer. Then, after you've driven for a while, return to the gas station and fill the gas tank to full. The amount of gallons that you purchased is the amount of gas that you used from full tank to full tank after driving for that time. That number goes in the denominator of the equation. The number of gallons will appear on the pump display and on your receipt. When refilling the second time, you'll also record the mileage on your odometer. The change in

mileage is the new mileage recording minus the previous mileage recording, and that number goes in the numerator of the equation.

$$\frac{\text{current mileage} - \text{previous mileage}}{\text{number of gallons used}} = \frac{\text{change in mileage}}{\text{gallons}} = \text{miles per gallon (MPG)}$$

When shopping for vehicles, you can look up the gas mileage as one of the features. (Go to any page past the home page at www.CrawfordsAutoService.com to use the free tool on the sidebar). The reported gas mileage is a statistical average that the vehicle generally gets and the vehicle that you purchase could get better or worse gas mileage depending on the condition of the vehicle and the roads where you will be driving.

There will be a monthly fee for vehicle insurance. Insurance fees will vary by the amount of coverage that you want. Liability insurance only pays for any damages that you might cause to the other party when you get in an accident and you are at fault. It won't pay to replace your vehicle or for your potential medical bills. You'll also want to consider whether you want roadside service in case the vehicle breaks down, or coverage for car rental fees in case you need a replacement vehicle while your vehicle is repaired. This additional coverage cost more per month.

There are many car insurance companies. Some of the more frequently advertised companies are Geico, All State, Progressive, Farmers, Esurance, and Liberty Mutual. Yet, there are many, many others. Their advertisements often tout that by simply giving them a call you could save a significant amount on your monthly insurance bill. That is true because each of their coverage plans are catered to specific types of drivers and these plans change from year to year. Hypothetically, this year Insurance Company A might have better rates for the common commuter with nothing on their driving record, while Insurance Company B might have the best rates for single mothers who are transporting three or more children on a regular basis. When they determine the monthly rate, they take many factors into consideration and many of these factors are company secrets that aren't publicly announced to potential customers. So, the best way to find the best deal is to get a quote from each company.

Some ways to reduce your monthly insurance cost are to never get a speeding ticket, never get in an accident, get good grades if you're a student, get married, be within a certain income bracket (not too low or too high), be female, and stay in frequent contact with the insurance company. Most of these factors are based on statistics. They're not being sexist or having other forms of bias; they have the research and numbers to justify charging a higher monthly fee for drivers who are at a higher risk. Also, many insurance companies offer discounts if you combine your car insurance with other types of insurance that they offer, such as home owner's insurance. They call it bundle discounts.

Shopping for the best car insurance can be a long process. Without a doubt there is a large percentage of car insurance customers who are paying more because they're too

intimidated by the research that is required for finding the best deal. You should get used to the idea that you'll frequently need to call the insurance company and be put on hold to wait for a representative. Be adamant enough with the representatives to get the best deals and avoid getting ripped off, yet be courteous and professional enough so that the representative will still want to help you. Shopping for car insurance can start simultaneously with shopping for the vehicle. Some companies may be able to help you identify the vehicles with the lowest monthly insurance rates. Yet, some of them might not be able to provide a quote until you can tell them which vehicle you'll be driving.

Besides the vehicle price, gas and insurance, there will be yearly fees for vehicle registration. You can find out the yearly registration fee by contacting your local Motor Vehicle Division (MVD or DMV) or your state's department of transportation. Some states require vehicle inspections and emissions testing before your vehicle can be registered. This information is also available at the DMV.

There will also be costs for maintenance and repair. The best way to reduce these costs is by taking care of the vehicle and following the maintenance chart in the owner's manual. If the vehicle has a service light illuminated on the dashboard or if the vehicle starts to have symptoms - don't neglect it. Neglect will lead to further damage, which will require more expensive repairs. A simple example is brake pad replacement. Replacing the brake pads could cost about \$200; but if you wait until the pads wear down completely and you start grinding metal on the rotor, then the repair could easily be \$800 or more (review Chapter 10 for brakes). If the vehicle is well-maintained, it will last a lot longer -- maybe even 15 years longer or more. Overall, it costs less to maintain a vehicle than to buy new vehicles more frequently.

Maintenance costs will be a factor for determining which vehicle to purchase since some makes and models cost more to maintain than others. Often, a more expensive sales price of the vehicle also means that replacement parts and maintenance will cost more. Some car manufacturers could even have the same part for the basic and sporty models. Yet, if the same part is ordered for the sporty model then it will cost more. The parts manufacturer figures that if the customer could pay for the sportier model then they can also pay more for the part, even if it's the exact same part with a different label.

Review of Vehicle Expenses:

- Sales price/monthly loan payment
- Monthly insurance payment
- Yearly registration fee
- State inspection fees
- Gas
- Regular maintenance
- Repairs

Once you're able to determine a ballpark figure for your monthly expenses of owning a vehicle, you'll be ready to start shopping. Some people find more comfort in purchasing a vehicle from a dealership because the organization within a brick and mortar facility

gives them a false sense of security. The problem with purchasing from a dealership is that they add unnecessary services and fees. For example, in Arizona they might add a "desert care package" and it will be listed with all the other fees. Since most customers don't know what the desert care package is, they don't ask about it. It essentially means that they tinted the windows without asking if you wanted it, and they will absolutely be charging you more than it would cost to tint the windows privately. They might also list "theft protection" as one of the fees. This means that they had a technician etch a number into the windows. They might charge \$200 for this service which takes the technician about 10-15 minutes to perform. Also, if your vehicle gets stolen, the police department won't use this number to identify your vehicle. They'll use the VIN (vehicle identification number).

The dealership will have many tricks for justifying an increased price on the bottom line. You can avoid some of these expenses by going through each item on the list and asking them to describe exactly what this means. Don't accept the sales description; tell them to really explain it. Then, if you don't want it on the bill, tell them to take it off. If you buy from a dealership you can expect to spend the entire day there. Dealerships also offer poor trade-in value for your prior vehicle.

If you decide to buy from a dealership, the best time of the year to buy is December, particularly on Christmas Eve and New Year's Eve. In any given month, the inventory on the lot isn't necessarily owned by the dealership. They have the vehicles on a "floor money" loan. If they don't keep the vehicle beyond a certain time period, they don't have to pay interest on the loan, and they make the profit from the sale without an additional expense. If you happen to pick a vehicle that is near the end of its loan period, then the dealership might be willing to sell it at a cheaper price. December is a particularly good time since people are more willing to buy during the holidays and the dealerships want to increase their sales numbers before the end of the year. This makes them more willing to negotiate, regardless of whether the loan period for the vehicle is ending.

If you buy from a private owner, there is no guarantee that they won't tell you little white lies about the vehicle in order to get you to buy it. However, a private owner won't be as likely to trick you into spending more for the vehicle than it's worth. There are tools that you can use to determine the value of the vehicle, and give you a more accurate starting point for a fair price.

Before deciding which vehicle to purchase, you'll want to write down some of the features you want, or decide on the purposes that the vehicle will serve. A pickup truck might make an excellent working vehicle, but the gas mileage could make it a lousy commuter vehicle. Will it be meant for one driver or more than one driver? How many passengers will be transported on a regular basis? Do you need a lot of trunk space? Do you plan on driving it until it dies, or will you sell it once it reaches a certain age or mileage? If you know that you'll eventually sell it, then you'll want to pick a make and model with a good reputation for resale value. All these features and more will help determine which vehicle you should look for.

If you buy from a private owner, the shopping will begin within the comfort of your own home. Some resources to find cars for sale include www.Craigslist.org, www.AutoTrader.com (and the Auto Trader print publication), Yahoo! Autos (autos.yahoo.com), www.Cars.com, and many free publications which are given away at local gas stations and outside public libraries.

When you find a vehicle that interests you, look up the make and model on Kelly Bluebook (www.KBB.com) to see the listed value. Sometimes a seller will list it for higher than the Kelly Bluebook price on purpose. There could be a variety of reasons for doing this, which include: hesitation to sell the vehicle, hope to sell it for more, upgrades which the owner added, or simply the expectation to negotiate.

If the vehicle says "OBO", it means "or best offer". This is an open invitation to negotiate. There may also be a variety of other abbreviations, especially if the ad is in print. Printed advertising fees are based on the number of characters or words, so the seller is trying to save money on the ad. If there is ever an abbreviation that you don't understand, look for an abbreviation key in the publication or look it up online.

If the vehicle has a "restored title", that means that at one time the vehicle had enough damage that the cost of repair was more than the total value of the vehicle. It may have been in an accident, flood, or other event to cause the damage. The repairs can include anything from engine repair to cosmetic changes to the vehicle. Generally, restored titles are less expensive, but the risk that there is something wrong is much greater.

Once you find a vehicle you're interested in, call or email the owner for more information. Since the ad may not have all the information you need, here are some questions you might want to ask:

Go through the features listed on Kelly Blue Book and gather any information you need that is not on the ad (Is it a two door or four door? Does it have a CD player, etc.)

If you're a non-smoker, was the vehicle ever driven by a smoker? A smoker wouldn't care much either way, but a non-smoker will find it's very difficult to get the smell of smoke out. Smokers who know they'll sell their vehicle eventually should never smoke in that vehicle because it reduces the resale value.

Has it had its regular maintenance? Oil changes at 5,000 miles? Etc. -- A vehicle with 100,000 miles that has had regular maintenance is better than a vehicle with 20,000 miles and never been maintained.

"Would it be OK if I test drove it to my mechanic as part of the evaluation?"

Is the Carfax provided? -- A Carfax is a report of all the times the vehicle has had an insurance claim for repairs. (<http://www.Carfax.com>) If you buy from a dealership, they usually include the Carfax. If you buy from a private owner, they

may or may not provide the Carfax since it costs extra. Auto Trader online has a place which indicates if the Carfax is available.

What was the car used for and where was it driven most of the time? Were dirt roads a part of the regular commute? Etc. -- Some of the best vehicles were only driven to the grocery store and home by an old lady who never went anywhere else and always took care of her things. Buying a used car from an organization who regularly kept them maintained for top reliable performance can also be a good source, such as an LDS Mission or a business.

Is the price negotiable?

If you're satisfied with the phone or email interview, then you'll schedule a time with the owner for seeing the vehicle.

After reading this book, you'll have a much greater advantage when evaluating a potential vehicle for purchase. You'll know to check the dashboard lights, the horn, the exterior lights, the battery, and many other parts of the vehicle because now you're familiar with how a vehicle works. You'll want to make sure it comes with a complete spare tire kit. Try looking down the side of the vehicle at different angles to see how the light reflects off the paint. If you detect two different coats of paint or areas where touch up paint has been applied then ask the seller about it. If the side panels and doors look smooth from one angle but then you detect some waviness when looking from a different angle, then the vehicle may have been in a side-impact collision and its safety features could be compromised.

You'll want to test drive the vehicle. See how it handles, accelerates and brakes. Go to a stretch of road like a freeway onramp or a long stretch between street lights where you can floor it. At some point in the inspection, you'll ask for a Carfax report or any of the information the seller might have on previous maintenance and repairs.

One of the smartest things you can do is take the car to a trusted mechanic as part of the evaluation. Find a place where you can develop a direct working relationship with the technician and not a service writer (review Chapter 11 for a description of service writers). Crawford's Auto Repair would be your best choice for a pre-purchase inspection if you live in the Mesa-Chandler-Gilbert area of Arizona. Some shops offer a free estimate but if they know you're requesting the evaluation to buy a vehicle, then they might charge for the inspection since there is less of a chance of you buying their repair services. The inspection fee will be worth it because the trained eye of the mechanic and the tools they use for diagnostics will enable them to spot things that you don't even know to look for. They'll look at the body of the vehicle from the inside, raise it up and look at the drive train and the underside of the engine, the brakes, and they'll attach their diagnostic device to the vehicle computer to receive any trouble codes that are stored on the vehicle's computer. A mechanic's inspection will tell you much more information than simply looking at the vehicle or test driving it yourself. And a seller who is confident in the value of the vehicle will allow you have it evaluated by a mechanic.

After a personal inspection of the vehicle and the mechanic's inspection, if possible you'll want to use an internet-enabled device to go through the Kelly Blue Book estimate again. Now that you have more information, you'll be able to get a more accurate estimate from Kelly Blue Book. Also, ask the mechanic for his best estimate on what the vehicle is worth. Between Blue Book and the mechanic, keep this baseline estimate in mind and do not go over it when negotiating. First of all, are you willing to pay this baseline estimate for the vehicle? If you don't want the vehicle enough to negotiate, then just let the owner know that after evaluating the vehicle you're not interested. If you are interested then you can start negotiating.

Consider the asking price of the vehicle. Is it lower than your baseline estimate? If it is, then it's your new baseline and do not go above it. If the asking price is above your baseline estimate then still do not go above your baseline. You'll want to make a counter offer to be as low as it can be without being offensive. It should at least be a couple hundred dollars lower than the Kelly Blue Book estimate. And you'll use the information you gathered during the inspection to justify the lower offer. If it needs a repair, then you'll mention that the price of the repair should be deducted from the asking price.

Be patient. Do not get excited to buy a vehicle. Read the seller's body language. Hold your ground. Read a book on negotiation, or many books. There is so much to this art and usually the better negotiator gets the deal he or she wants while the other person makes compromises. If you're too anxious to buy the vehicle or if you're too lazy to go through the process of calling sellers and inspecting a vehicle more than once, then you'll probably pay more. Expect to go through this process a few times before finding a satisfying deal.

After you agree on a price, the seller will take the title to the Division of Motor Vehicles (DMV) or a private title shop and get the title notarized for selling the vehicle. You might use that time to go to the bank or a title loan store to get the money to pay for the vehicle. You can arrange for the best type of payment with the seller. If you pay for it in full from your bank account, then paying with a cashier's check made out to the seller may be more secure than carrying cash. Then you and the seller will meet up again to trade the payment for the title and keys. After you receive the title, you'll have to take it to the DMV or to an independent title service shop to have a new title drawn up in your name and get your license plate. Within the next 10 days you'll also need to call the insurance company to have the new vehicle added to your current coverage plan or purchase new insurance.

Finding the right vehicle for your needs at the right price will be very rewarding. If you do your homework, put in the effort and follow the steps in this chapter, then you'll be able to find a good vehicle that you can afford. Good luck!

About the author of this chapter: Rex Kimball has been involved in internet marketing for over seven years and he is the owner of www.MirexMarketing.com. If you're a business owner in need of additional promotion then Mirex Marketing can help. An ebook (or electronic book) such as the one you're currently reading is an excellent way to promote your website and gain customer trust through honest disclosure and consumer education. Contact Mirex Marketing today!

About the author of this ebook: Jeff Crawford has been an auto technician for over 20 years and he is the owner of Crawford's Auto Repair in Mesa, Arizona. He is a firm believer that auto repair customers deserve to have direct contact with the technician who fixes the vehicle. If you live near the Mesa, Arizona area, then check out Crawford's Auto repair for all your vehicle maintenance and repair needs.



Quality you can trust!

2855 S Alma School Rd. Suite 107
Mesa, AZ 85210
480-201-0740

www.CrawfordsAutoService.com
crawfordsautomotive@gmail.com



Download the PDF of this book for free:

<http://crawfordsautoservice.com/crawfords-auto-repair-guide-free-ebook/>

This book is also available in [Kindle Format](#) and [Paperback](#).